

5G MiFi M2000

Global Mobile Hotspot

INSEEGO COPYRIGHT STATEMENT

© 2020 Inseego Corp. All rights reserved. Complying with all copyright laws is the responsibility of the user. Without limiting the rights under copyright, no part of this document may be reproduced, stored in or introduced into a retrieval system, or transmitted in any form or by any means (electronic, mechanical, photocopying, recording or otherwise), or for any purpose without the expressed written permission of Inseego Corp.

SOFTWARE LICENSE

Proprietary Rights Provisions:

The software drivers provided with this product are copyrighted by Inseego Corp. and/or Inseego Corp.'s suppliers. Although copyrighted, the software drivers are unpublished and embody valuable trade secrets proprietary to Inseego Corp. and/or Inseego Corp. suppliers. The disassembly, decompilation, and/or Reverse Engineering of the software drivers for any purpose is strictly prohibited by international law. The copying of the software drivers, except for a reasonable number of back-up copies is strictly prohibited by international law. It is forbidden by international law to provide access to the software drivers to any person for any purpose other than processing the internal data for the intended use of the software drivers.

U.S. Government Restricted Rights Clause:

The software drivers are classified as "Commercial Computing device Software" and the U.S. Government is acquiring only "Restricted Rights" in the software drivers and their Documentation.

U.S. Government Export Administration Act Compliance Clause:

It is forbidden by US law to export, license or otherwise transfer the software drivers or Derivative Works to any country where such transfer is prohibited by the United States Export Administration Act, or any successor legislation, or in violation of the laws of any other country.

TRADEMARKS AND SERVICE MARKS

Inseego Corp. is a trademark of Inseego Corp., and the other trademarks, logos, and service marks (collectively the "Trademarks") used in this user manual are the property of Inseego Corp. or their respective owners. Nothing contained in this user manual should be construed as granting by implication, estoppel, or otherwise, a license or right of use of Inseego Corp. or any other Trademark displayed in this user manual without the written permission of Inseego Corp. or its respective owners.

- MiFi® and the MiFi logo are registered trademarks of Inseego Corp. • Microsoft and Windows are either registered trademarks or trademarks of Microsoft Corporation in the United States and/or other countries.
- Linux® is the registered trademark of Linus Torvalds in the U.S. and other countries.

The names of actual companies and products mentioned in this user manual may be the trademarks of their respective owners.

Document Number: 90029587 Rev 1

Contents

Introduction and Getting Started	6
Overview.....	7
Key Features.....	7
Description.....	7
Side View.....	8
Display View.....	8
Status Indicators and Icons.....	9
Getting Started.....	10
Installing a SIM Card.....	10
Turning On and Off.....	12
System Requirements.....	12
Finding your Wi-Fi Name and Password.....	12
Connecting Devices to the M2000.....	13
Caring for your M2000.....	13
Charging.....	13
Replacing the Battery.....	14
Battery Tips.....	15
Unlocking the SIM Card.....	16
Resetting the M2000.....	16
Care Tips.....	17
Touchscreen	18
Overview.....	19
Home Screen.....	19
Navigation Tips.....	20
Wi-Fi Settings.....	20
Wi-Fi.....	20
Band Selection.....	21
Wi-Fi Name/Password.....	21
Wi-Fi Protected Setup (WPS).....	22
Connected Devices.....	23
Connected Devices (Details and Blocking).....	23
Blocked Devices (Unblocking).....	23
Data Usage.....	24
Settings.....	25
Universal Charging.....	26
Software Updates.....	26
About.....	27
Help.....	27
Admin Website	28
Overview.....	29
Home Page.....	29
Side Menu.....	29
Admin Password.....	30
Changing the Admin Password.....	30
Hiding the Admin Password on the Touchscreen.....	30
Managing Data Usage.....	31
Data Usage Page.....	32
Managing Wi-Fi Settings.....	33
Settings Tab.....	34
Primary Network Tab.....	36

Guest Network Tab	38
Managing Connected Devices.....	40
Connected Devices Page	41
Managing Settings	43
Preferences Tab.....	44
Software Update Tab	49
Backup and Restore Tab.....	50
GPS Tab	52
Advanced Tab.....	53
Viewing Info About the M2000	54
Internet Status Tab.....	55
Diagnostics Tab.....	57
Device Info Tab.....	59
Logs Tab.....	60
Getting Help	61
Help Tab.....	62
Customer Support Tab	62
Advanced Settings	63
Overview.....	64
Using Advanced Settings.....	64
Networks Tab	65
Manual DNS Tab.....	66
SIM Tab.....	67
Firewall Tab.....	69
Mac Filter Tab.....	70
LAN Tab.....	72
Port Filtering Tab	74
Port Forwarding Tab.....	77
VPN Tab.....	80
Inseego Connect Tab	82
Troubleshooting and Support	83
Overview.....	84
First Troubleshooting Steps.....	84
Common Problems and Solutions	84
My M2000 powered off without pressing the Power button.....	84
No service is available	85
My M2000 has no power/touchscreen doesn't display when I press the Power button	85
I forgot my Wi-Fi password.....	85
I forgot my M2000 Admin website password	85
I cannot connect a device to my M2000	85
I see the network name, but cannot connect a device to my M2000.....	85
I want to see how many devices are connected	86
I want to see the firmware (software) version installed on my M2000	86
I want to see the phone number for my M2000.....	86
I want to see the battery level of my M2000.....	86
I want to turn my M2000 off	86
I want to know if my M2000 is still on when the touchscreen is dark	87
Technical Support	87
Product Specifications and Regulatory Information	88
Product Specifications.....	89
Device	89
Environmental	89

Power	90
Network Connectivity	90
Wi-Fi.....	90
Software.....	90
Warranty and Services	90
Regulatory Information.....	91
Product Certifications and Supplier’s Declarations of Conformity.....	94
Wireless Communications.....	94
Limited Warranty and Liability.....	94
Safety Hazards	95
Proper Battery Use and Disposal.....	96
Glossary	98
Glossary	99

1

Introduction and Getting Started

Overview

Description

Status Indicators and Icons

Getting Started

Caring for your M2000

Overview

The 5G MiFi M2000 is Inseego's 2nd generation 5G mobile hotspot, providing download speeds up to 2.7 Gbps* with remarkably fast 4G LTE fallback for extended coverage. The M2000 supports up to 30 connected devices with enterprise-grade dual-band Wi-Fi, or you can tether directly using the USB Type-C port.

Key Features

- Wi-Fi 6 enables up to 40% faster Wi-Fi speeds, up to 4x increase in data throughput per user even with multiple devices connected, and improved battery efficiency versus Wi-Fi 5.
- WPA3 protocol provides security improvements, more robust authentication, and individualized data encryption, and offers additional capabilities for personal and enterprise networks.
- Large 2.4" touchscreen display allows you to manage connected devices, view data usage, configure settings, and more – all from your device.
- Easy-to-use Admin Web User Interface provides additional access to manage your M2000 environment, including advanced mobile device management tools such as GPS location, device setting configuration, logs, and more.
- Enterprise-grade VPN passthrough and the ability to install a VPN client.
- Removable 3500mAh battery keeps devices connected all day†, and ultra-fast charging with Qualcomm® Quick Charge™-enabled technology. You can use the M2000 as a battery bank to charge your phone, tablet, and other connected devices.

Description

The Inseego 5G MiFi M2000 package includes:

- 5G MiFi M2000
- Pre-installed 3500 mAh Li-Ion Battery
- Qualcomm-Enabled Quick Charger
- USB Type C to A Cable
- Quick Start Guide

* Theoretical values, speeds achieved by connected devices vary based on network coverage, Wi-Fi connection and device capability.

† Theoretical values, battery life and charge time may vary depending on the number of connected devices and activity.

Side View

Press and hold the Power button for three seconds to turn your M2000 on and off. Press and release the Power button to wake up the display.

Connect to the Quick Charge charger or tether to a device with the USB-C port.







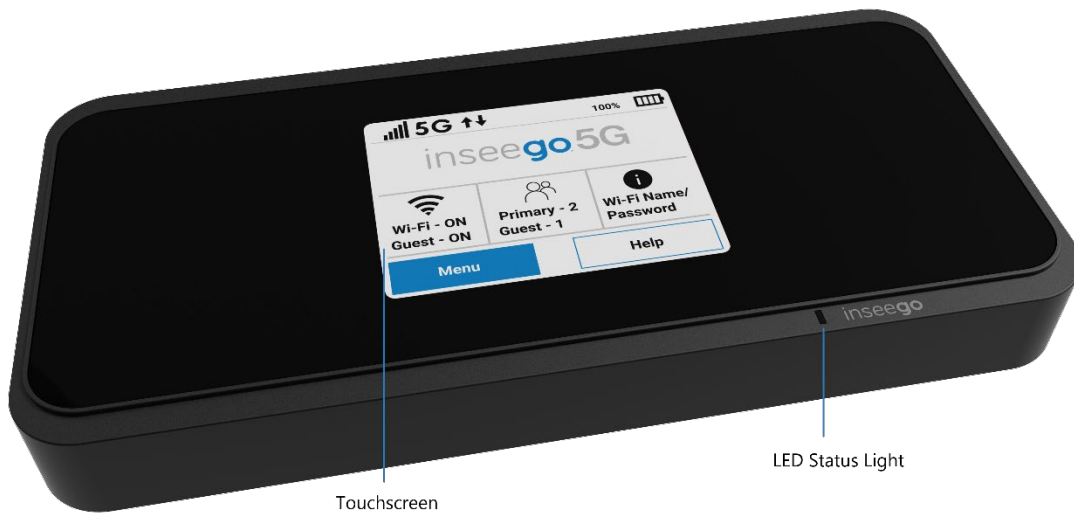









Display View

The 2.4 inch touchscreen displays and allows you to view Wi-Fi name and password, connected devices, data usage, and more. Swipe through screens and tap the arrows, buttons, and icons to access available menu options.



Status Indicators and Icons

The M2000 uses the following status indicators and display icons.

Display Icon		Description
No Icons		The M2000 is powered off or not receiving power, or the screen is in power-saving mode.
Home		Home
Network Signal Strength		Network Signal Strength Indicator. More bars indicate more signal strength.
Activity Indicator		Data is moving between the mobile network and the M2000.
Wi-Fi		The M2000 Wi-Fi network is on.
Connected Devices		Displays number of Wi-Fi devices connected to your M2000.
Information		Tap to view more information (on Home screen tap to view Wi-Fi network names and passwords).
Multiple Screens		Indicates you can swipe left/right to view more screens.
Battery Charged		Battery is fully charged.
Battery Needs Charge		Battery is critically low and the M2000 will shut down unless the battery is connected to the charger.
Battery AC Charging		The M2000 is connected to the AC charger and charging.
Battery USB Charging		The M2000 is connected via USB and is charging a connected device.
No SIM		No SIM card is detected.
Locked SIM		SIM card is locked. The real-time data usage meter will not display.
SIM Error		SIM card error. Check that your SIM card is properly installed.
USB Tethered		Device is connected to the M2000 via USB.

Getting Started

Important: Before you use your M2000, charge the battery for at least three hours to ensure a full initial charge. When fully charged, the battery has all day life.

Installing a SIM Card

Your SIM card is a small rectangular plastic card that stores your phone number and important information about your wireless service. The M2000 supports only Nano SIM cards. If the device SIM is **NOT** already inserted into this device, select the correct SIM for this device.



CAUTION: Always use a factory-made SIM card supplied by the service provider. Do not bend or scratch your SIM card. Avoid exposing your SIM card to static electricity, water, or dirt.

To install a SIM card:

1. Insert a fingernail at the edge of the battery cover and lift and remove the battery cover. Set the cover aside.

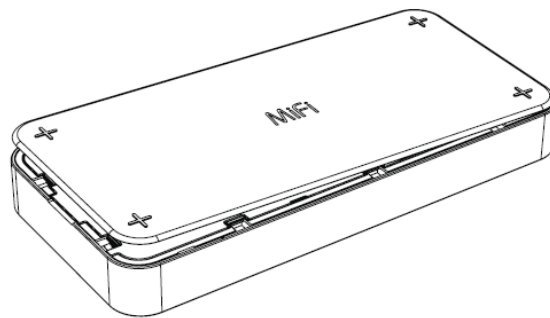

2. Remove the battery from the battery well.

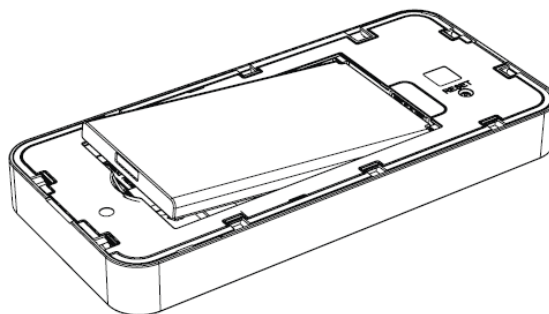

3. If necessary, remove the SIM card from the outer card, being careful not to touch the gold colored contacts.

4. Hold the SIM card with the gold-colored contact points facing down.
5. Push down and insert the SIM card into the slot. The SIM card MUST remain in the SIM card slot when in use.

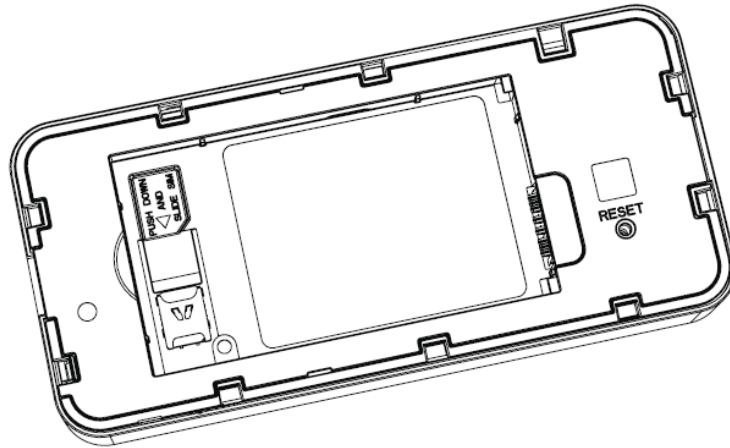

NOTE: Should your SIM card be lost or damaged, contact your network operator.

Turning On and Off

To turn your M2000 on, press and hold the Power button for three seconds. The Home screen appears.



To turn your M2000 off, press and hold the Power button for three seconds until you see the Power Off screen.

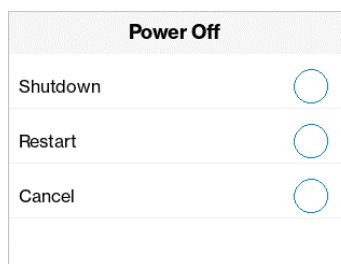

Then select **Shutdown**.

To wake up the display, press and release the Power button.

System Requirements

Any device with Wi-Fi capability can connect to your M2000.

The M2000 must have proper data service to function and is compatible with all major operating systems and the latest versions of browsers.

Finding your Wi-Fi Name and Password

Tap **Wi-Fi Name/Password** on the Home screen. The name and password for your M2000 primary network is displayed. Swipe left to see the credentials for the guest network.

Important: The default Admin password is the same as the primary network's default. To change either password, sign in to the M2000 Admin website.

Connecting Devices to the M2000

Your M2000 has two Wi-Fi networks, primary and guest, and lets you connect up to 30 Wi-Fi capable devices. For added security, share your guest network instead of your primary network. The guest network is off by default. You can turn it on from either the M2000 touchscreen or the Admin website.

To connect devices to your M2000:

1. Turn on the device you want to connect. The M2000 will broadcast its own wireless network and name.
2. On the device, open the list of available Wi-Fi networks. Select the M2000 primary or guest network and enter the password. Once connected to the Internet, the M2000 Home screen displays the connected device.

NOTE: You can view or change M2000 settings on the M2000 touchscreen or by connecting to the Admin Web UI from the primary network at <http://my.mifi> or <http://192.168.1.1>.

Caring for your M2000

This section provides information on charging, battery replacement and tips, unlocking the SIM card, general care, and restoring your M2000 to factory default settings.

Charging

You can check the battery level and charging status of your M2000 from the Home screen.

Important: Before you use your M2000, charge the battery for at least three hours to ensure a full initial charge. When fully charged, the battery has all day life.

Charging with Quick Charge Charger

To charge the battery with the Quick Charge charger:

1. Connect the USB-C end of the USB cable into the charging port of the M2000.

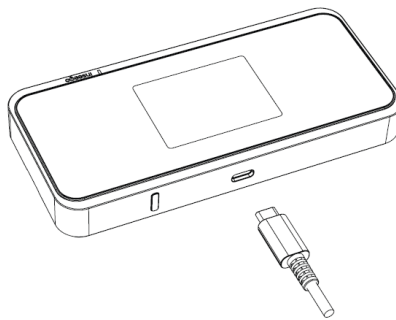

2. Connect the other end of the USB cable into the Quick Charge charger and then plug the charger into an appropriate electrical outlet. When the battery is fully charged, a notice appears on the touchscreen asking you to disconnect the charger.

Charging with USB

You can also charge your M2000 from another device, such as a computer, with USB.

To charge the battery with USB:

1. Connect the USB-C end of the USB cable into the charging port of the M2000.
2. Connect the USB-A end of the USB cable into another device, such as a laptop. The USB Connection Options touchscreen appears.

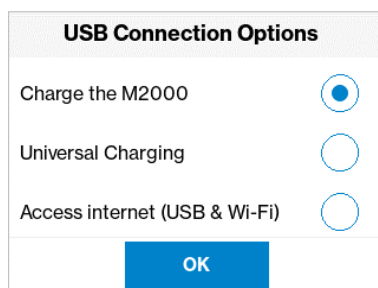

3. Select **Charge the M2000** and tap **OK**.
4. When the battery is fully charged, a notice appears on the touchscreen asking you to disconnect the charger.

Before using your M2000, read the battery safety information in the Safety Hazards and Proper Battery Use and Disposal sections and the end of this guide.

CAUTION: Use only batteries and chargers that have been approved by Inseego for optimal performance and safe operation of your M2000.

Replacing the Battery

CAUTION: Whenever you remove or insert the battery, ensure your M2000 is not connected to any device or power source. Never use tools, knives, keys, pens or any type of object to force the door open or to remove the battery. Using any of these types of objects could result in puncturing the battery.

To remove and replace the battery:

1. Insert a fingernail at the edge of the battery cover and lift and remove the battery cover. Set the cover aside.

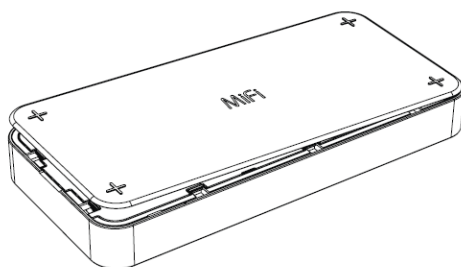

2. Insert your finger into the battery removal divot and lift the battery out of the battery compartment.

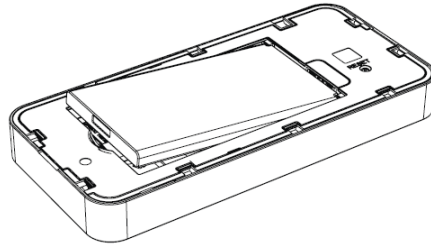

3. Align the gold contacts on the new battery with the gold contacts on the M2000 and gently slide the battery into place.
4. Replace the cover by setting it on the M2000 where the notches align, then press on the cover until it clicks into place and is flat across the entire bottom surface.

Battery Tips

WARNING! Always use only approved batteries and chargers with your M2000. The warranty does not cover damage caused by non-approved batteries and/or chargers.

- Do not use sharp objects or use excessive force to remove the battery or to access the battery well, this may damage the M2000 and the battery.
- The battery discharges more rapidly as additional devices access your M2000.
- Battery life depends on the network, signal strength, temperature, features, and accessories you use.
- New batteries or batteries that have been stored for a long time may take more time to charge.
- When storing your battery, keep it uncharged in a cool, dark, dry place.
- When charging your battery, keep it near room temperature.
- Never expose batteries to temperatures below -20°C (4°F) or above 60°C (140°F).
- Never leave the M2000 in an unattended vehicle where it can get too hot or too cold.
- Some batteries perform best after several full charge/discharge cycles.
- It is normal for batteries to gradually wear down and require longer charging times. If you notice a change in your battery life, it is probably time to purchase a new battery.

Unlocking the SIM Card

You can create a PIN code to lock your M2000 SIM card on the Admin Web UI (Settings > Advanced Settings > SIM). When the SIM is locked, your M2000 will not have access to the Internet. A display appears in the InfoPanel of the Home screen.

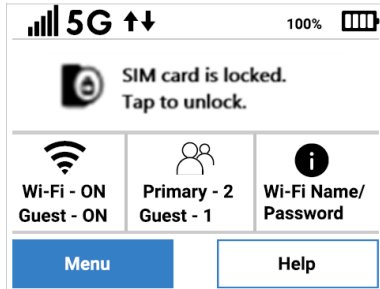

Tap the message to unlock the SIM card.
Or you can tap Unlock SIM from the Help menu.

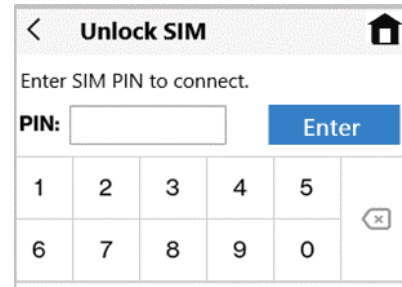

Enter the PIN and tap Enter.

CAUTION: If you run out of PIN attempts, your SIM is PUK (personal unblocking key) locked and you must contact your network operator for the PUK code. You must enter the PUK code in the Admin website. If you enter the wrong PUK code, your SIM card will be permanently locked.

Resetting the M2000

You can reset your M2000 to factory settings using the RESET button on the M2000, from the M2000 touchscreen, or from the Admin Web UI.

CAUTION: Resetting returns your M2000 to factory settings, including resetting the Wi-Fi name and password. This disconnects all devices.

Resetting with the RESET button

To reset using the RESET button on the M2000:

1. Insert a fingernail at the edge of the battery cover and lift and remove the battery cover. Set the cover aside.

The master RESET button is in a small hole located on the bottom of the M2000, underneath the battery cover.



2. Place one end of an unfolded paper clip into the **RESET** button hole and press until the screen displays **M2000 Resetting** (about five to six seconds). Your M2000 restarts with factory settings.

NOTE: This option may be disallowed from the Admin Web UI (Settings > Preferences > Device Preferences).

Resetting from the M2000 touchscreen

To reset from the M2000 touchscreen, tap **Menu > Settings > Factory Reset**.

NOTE: This option may be disallowed from the Admin Web UI (Settings > Preferences > Device Preferences).

Resetting from the Admin Web UI

To reset the M2000 from the Admin Web UI, select **Settings > Backup and Restore** and select **Restore factory defaults**.

Care Tips

Inseego Wireless recommends the following care guidelines:

- Protect your M2000 from liquids, dust, and excessive temperatures.
- Do not apply adhesive labels to your M2000; they might cause the device to potentially overheat or alter the performance of the antenna.
- Store the M2000 in a safe place when not in use.

2

Touchscreen

Overview

Wi-Fi Settings

Connected Devices

Data Usage

Settings

Universal Charging

Software Updates

About

Help





Overview

You can manage, monitor, and customize your M2000 settings directly on the M2000 touchscreen, or by using the M2000 Admin Web UI. This chapter explains the features available with the touchscreen.

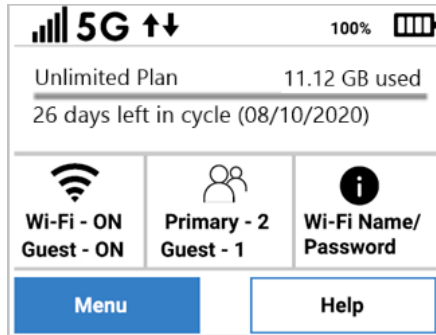

Home Screen

The Home screen lets you see what your M2000 is doing at a glance.



Status Bar: The top of the screen displays status indicators, which may include: network signal strength , network type (for example, **5G**), data traffic activity , battery **100%** , and USB tethered .

InfoPanel: This panel presents a carousel display of current information on your M2000. Initially, it displays device usage, but may also display other information, such as when Airplane mode is on, or if there is a SIM card error. Swipe left/right through the displays.

AppPanel: Displays whether Wi-Fi is ON or OFF (tap  to access the Wi-Fi menu). Displays how many devices are connected to your M2000 Wi-Fi primary and guest network (tap  to access the Connected Devices menu). Tap  to view the name and password for your primary network.

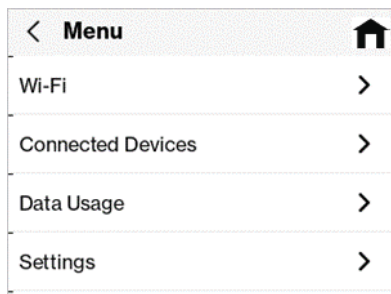

Menu provides access to all menu options
Swipe up/down to scroll through options

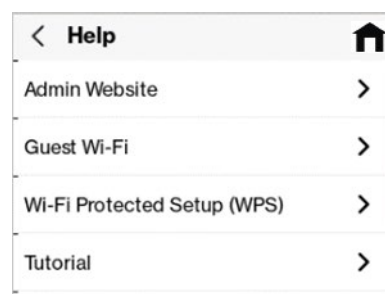

Help provides access to info screens and tutorial

Navigation Tips

- Tap on the arrows > to navigate through topics.
- Use 🏠 to return to the Home screen.
- A multiple screen icon —|— indicates there are multiple screens on that topic.
- Swipe left and right through screens.
- If there is a scroll bar visible on the right, swipe up or down to scroll.

Wi-Fi Settings

The Wi-Fi Settings screen allows you to turn Wi-Fi ON/OFF and select primary and guest network settings.

NOTE: Wi-Fi settings can be locked from the Admin Web UI. If they are locked, you will see an error message and they must be unlocked from the Admin Web UI Wi-Fi Settings page.

To manage Wi-Fi settings, tap the Wi-Fi icon  on the Home screen (or tap **Menu > Wi-Fi Settings**).

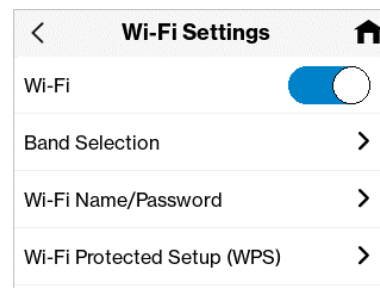
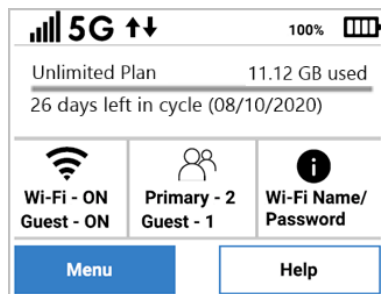

Make selections

Wi-Fi

Use the **Wi-Fi** ON/OFF slider to turn Wi-Fi ON or OFF. This selection affects primary and guest networks.

NOTE: If Wi-Fi is OFF, the only way to connect devices to the M2000 is by tethering with the USB cable.

Band Selection

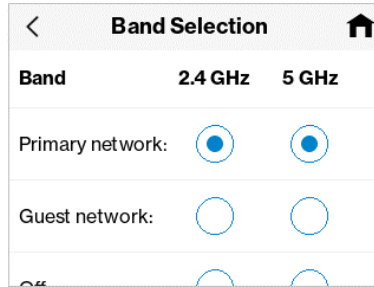

Use the default values as they appear or adjust them for your environment.

Each network can be accessed over two bands: 2.4 GHz and 5 GHz:

- The 2.4 GHz band is supported by all devices with Wi-Fi and should be used by devices that are a few years old or older. This band passes through walls better and propagates over longer distances, so it may have a longer range.
- The 5 GHz band is best for newer devices. It offers better throughput, reduced interference and faster data speeds, but does not pass through walls as well as the 2.4 GHz band.

NOTE: You must assign at least one band for the guest network before it can be turned on.

When you make a selection, M2000 notifies you that it is applying changes and returns to the screen when finished.

Tap  **Help me choose** for more information.

Wi-Fi Name/Password

Use the Wi-Fi Name/Password screens to view information on your primary and guest network and to find your passwords. (You can also access these screens by tapping the  icon on the Home screen.)



Swipe left to view the Guest Wi-Fi Network screen and left again to view information.

To turn on your guest network, assign it at least one band in **Wi-Fi Settings > Band Selection**.

NOTE: You can change or hide the network name and password information shown on these screens using the Admin Web UI Wi-Fi pages.

Wi-Fi Protected Setup (WPS)

Enabling Wi-Fi Protected Setup (WPS) allows compatible Wi-Fi devices to easily connect to your M2000 primary or guest network.

NOTE: If WPS is off, you can turn it on using the Admin Web UI Wi-Fi pages.

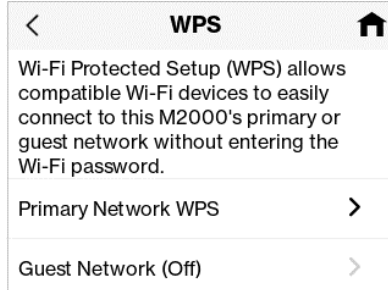

Tap a network

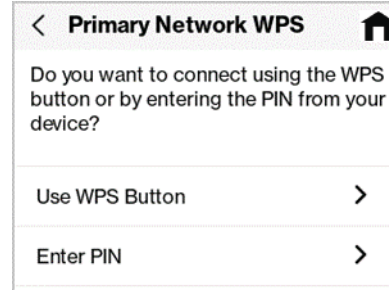

Select a connection option

Use WPS Button

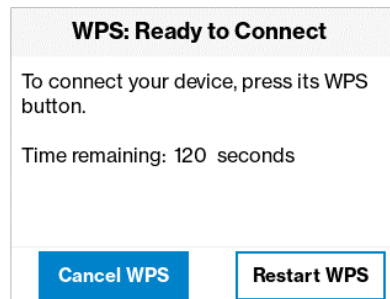

Press the WPS button on the connecting device. A notification appears when successful. If unsuccessful, tap Restart WPS to try again.

Enter PIN

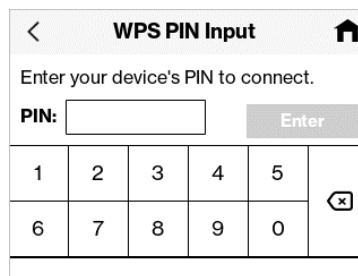

If connecting device has a WPS PIN, enter it and tap Enter.

Connected Devices

The Connected Devices screen lists all devices currently connected to your M2000, along with the network they are using. You can view device details and block or unblock devices from Internet access.

To manage connected devices, tap the connected devices icon  on the Home screen (or tap **Menu** > **Connected Devices**).

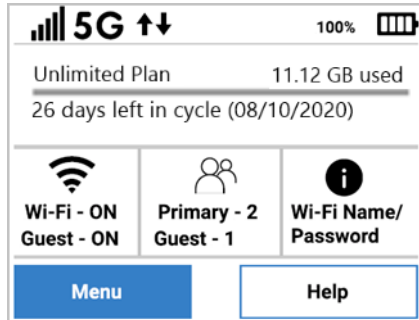

Tap 

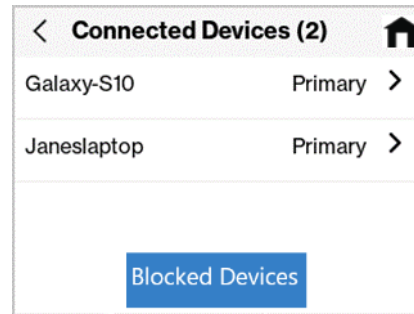

Tap a device for more details or to block devices
Tap Blocked Devices to unblock devices

Connected Devices (Details and Blocking)

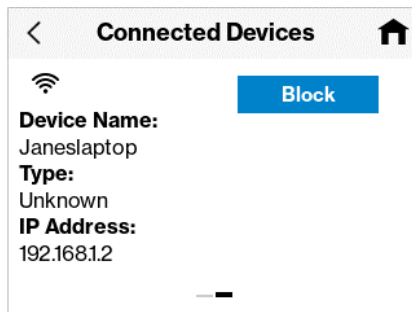

Tap Block to block
Swipe left/right for a different device

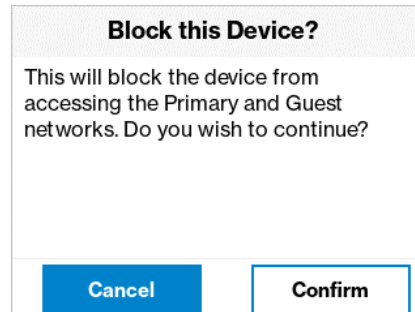

Tap Confirm to block the device

Blocked Devices (Unblocking)



Tap Blocked Devices to unblock



Tap Unblock. The device is removed from Blocked Devices and added to Connected Devices.
Swipe left/right for a different blocked device.

Data Usage

You can view data usage on the Home screen, or tap **Menu > Data Usage**.

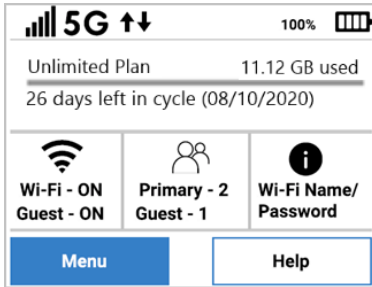

Tap Menu

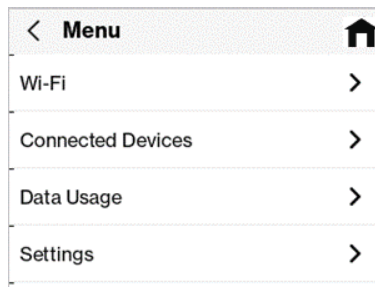

Tap Data Usage

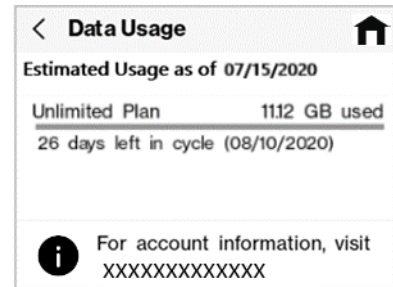

View estimated usage and plan info

NOTE: Data usage estimates may not include roaming. If roaming is on, an informational screen appears. Tap **Continue** for the Data Usage screen.

Settings

Use the Settings screen change various M2000 settings or reset your M2000 to the original factory settings.

NOTE: Settings can be locked from the Admin Web UI. If they are locked, you will receive an error message and they must be unlocked from the Admin Web UI (Settings > Preferences > Device Preferences).

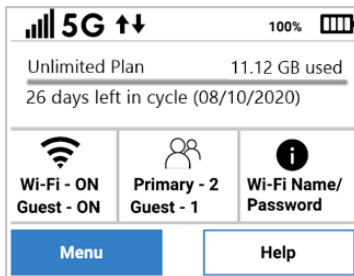

Tap Menu

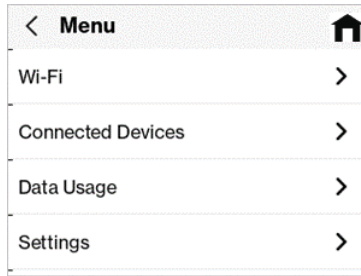

Tap Settings

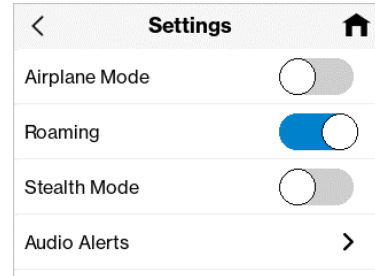

Set ON/OFF slider or tap a setting

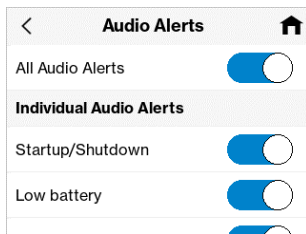

Slide desired alerts ON/OFF

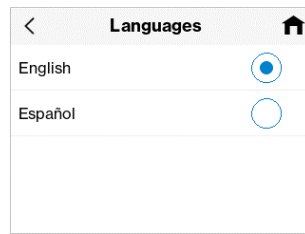

Set touchscreen language

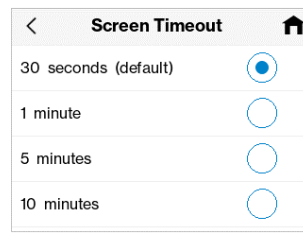

Set touchscreen timeout

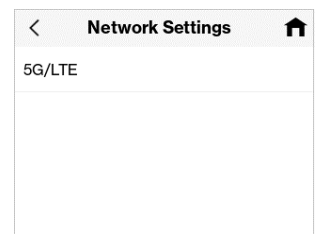

Select a network

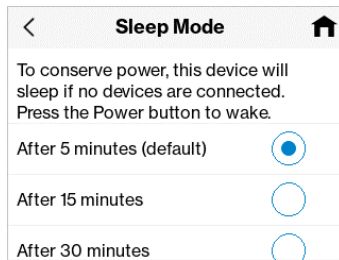

Set timer for sleep mode

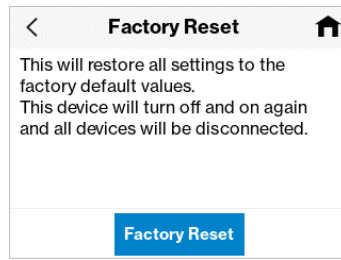

Tap Factory Reset to restore all settings to the factory default values. Your M2000 will turn off and then on again and all connected devices will be disconnected.

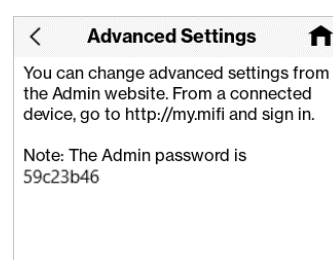

Use the Admin Web UI

NOTE: Factory Reset can be locked from the Admin Web UI. If it is locked, you will receive an error message and it must be unlocked from the Admin Web UI (Settings > Preferences > Device Preferences).

CAUTION: Factory Reset returns your M2000 to factory settings, including resetting the Wi-Fi name and password. This disconnects all devices.

Universal Charging

You can use the USB-C port on your M2000 to charge other devices, like a cell phone or tablet. The Universal Charging touchscreen provides battery and charging information.

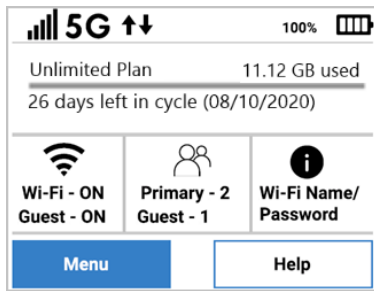

Tap Menu

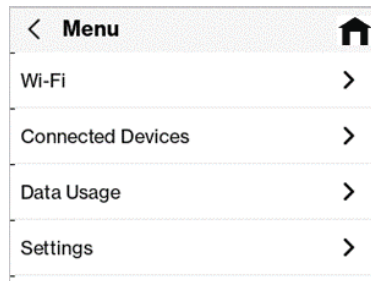

Swipe up and tap Universal Charging

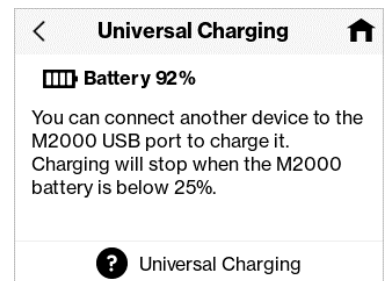

View charging capability

Tap ? for more info

Software Updates

Software updates are delivered to the M2000 automatically over the mobile network. Use the Software Updates screen to view the current software version, the last check for updates, update history, and to check for a new update.

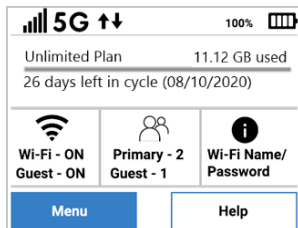

Tap Menu

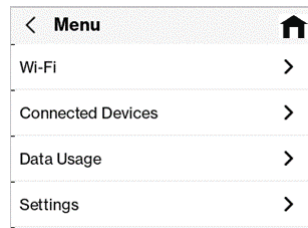

Swipe up and tap Software Update

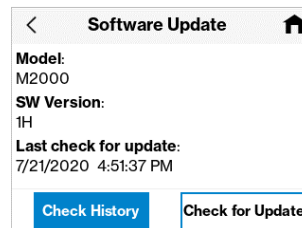

Tap Check History

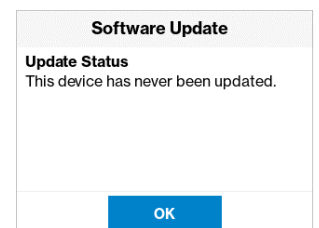

View History

Check for Update: Use this button to check for new software updates. **NOTE:** Software updates are delivered to the M2000 automatically over the network, so this is usually not necessary.

About

You can view detailed information about your M2000 with the About screen.

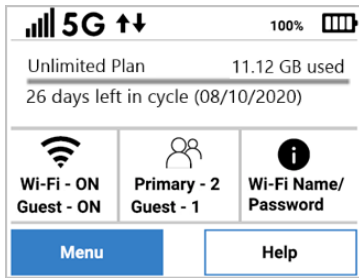

Tap Menu

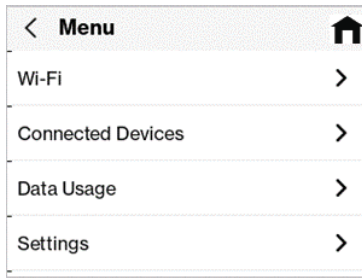

Swipe up and tap About

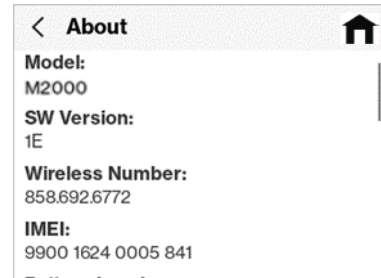

View details about your M2000

The About touchscreen provides the following information:

Model: M2000.

SW Version: The version of the software currently installed on your M2000.

Wireless Number: The phone number stored in the SIM card for your M2000.

IMEI: The International Mobile Equipment Identity (IMEI) for this device. This is a 15 digit code used to uniquely identify an individual mobile station. The IMEI does not change when the SIM is changed.

Battery Level: The percentage of charge currently on the battery.

Battery State: The state of the battery.

Internet Status: The current Internet status.

Technology: The current cellular data connection, for example, 5G.

Network: The name of the Mobile Network Operator (MNO).

Signal Strength: The strength of the cellular signal, measured in dBm. Higher absolute values indicate a stronger signal, for example: -80 dBm is a stronger signal than -90 dBm.

SNR: Signal to Noise Ratio. A measure of the ratio between signal strength and noise level. SNR values are positive, and higher numbers are better.

Roaming: Indicates whether roaming is on.

APN: The Access Point Name (APN) available from the network.

IP Address: The Internet IP address assigned to your M2000.

Help

When you see  on a screen, tap it for more information on that topic, or use the Help menu. The Help screen provides all the help topics and a tutorial for your M2000.

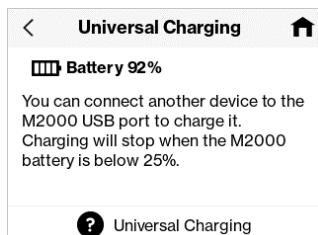

Tap 

or

Tap Help and then Select a topic

View Help topic

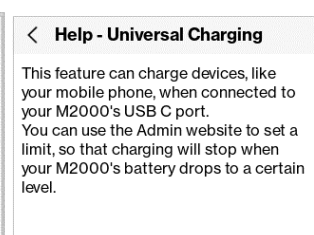
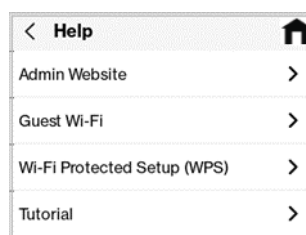
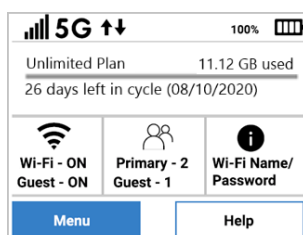

3

Admin Website

Overview

Admin Password

Managing Data Usage

Managing Wi-Fi Settings

Managing Connected Devices

Managing Settings

Viewing Info About the M2000

Getting Help

Overview

On a computer or device connected to your M2000, open any web browser and go to <http://my.MIFI/> or <http://192.168.1.1>.

Home Page

The Home page is the local gateway to configuring and managing your M2000. It displays current data usage and Wi-Fi status, lists currently connected devices, and offers links to other pages with option settings and help.

Click > in the bottom-right corner of a panel to access screens with further information and options.

The screenshot shows the inseeGo M2000 Home Page. At the top left is the inseeGo logo and 'M2000'. At the top right are signal strength bars, '5G' with up/down arrows, '100%' battery, and a 'Sign In' dropdown. The main content is divided into several panels:

- Data Usage:** A circular gauge shows 85% data used. Text indicates 'My Plan: 10.0 GB Data Plan', 'Data Usage: 8.5 GB remaining', and '8.5 GB of data remaining'. A bar chart shows 1.5 GB data used (blue) and 8.5 GB data remaining (grey). A '8 days to go' indicator is present.
- About:** Lists 'Internet Status: Connected', 'Network name: <carrier>', 'Technology: 5G', and 'Time connected: 01 days, 02 hrs, 23 min'.
- Connected Devices: 1:** A table with columns 'Device' and 'Network'. One device 'Janeslaptop' is listed with 'Primary' network.
- Wi-Fi:** Shows 'Primary Network: ON', 'Network Name (SSID): INS-M2000-38C2', 'Password: *****', and 'Guest Network: OFF'.
- Settings:** Shows 'Mobile Network: ON', 'Port Filtering: OFF', 'GPS: OFF', and 'System Update: Last system update: No updates applied.'
- Help:** Contains links for 'Overview', 'Setup', 'Tips', 'Security Features', and 'User Guide'.

Each panel has a right-pointing chevron (>) in its bottom-right corner. The footer contains the inseeGo logo, '© 2020 All rights reserved.', and 'www.inseeGo.com'.

Side Menu

Each subscreen in the M2000 Web User Interface includes a menu on the left, which you can use to return to the Home page or jump to other pages. The current page is indicated by a blue bar.

The side menu is a vertical list of items, each with a horizontal line to its right. The items are: 'Home', 'Data Usage', 'Wi-Fi' (which has a blue vertical bar to its left), 'Connected Devices' (with a red circle containing the number '1' to its right), 'Settings', 'About', and 'Help'.

Admin Password

The Admin password is what you use to sign into the M2000 Web UI. Initially, it is the same as the default password for your M2000 primary network. Tap **Wi-Fi Name/Password** on the Home touchscreen of your M2000 to view the password.

NOTE: You can set up separate Wi-Fi passwords both primary and guest networks in **Wi-Fi**, but these are different from the Admin password, which is for this Web Interface.

Important: It is critical that you change the Admin password from the default to keep the device and your network secure.

Changing the Admin Password

To change the Admin password:

1. Click the down arrow next to **Sign Out** in the top-right corner of any Web Interface page and select **Admin Settings > Change Device Admin Password**.
2. Enter your current Admin password, then click **Continue**.
3. Enter your current Admin password, then enter a new password and confirm it.
4. Select a security question from the drop-down list and type an answer to question in the **Answer** field. **NOTE:** Answers are case-sensitive.
5. Click **Save Changes**.

The next time you sign in to the M2000 Web Interface, use the new Admin password. If you cannot remember the password, click **I forgot the Admin password**. After you correctly answer the security question you set up, the current password is displayed.

Hiding the Admin Password on the Touchscreen

The Admin password can be viewed on the M2000 touchscreen by tapping **Admin Website** from the Help menu.

To hide the Admin password:

1. Click the down arrow next to **Sign Out** in the top-right corner of any Web Interface page and select **Admin Settings**.
2. Move the **ON/OFF slider** to the right to hide the Admin password on the M2000 touchscreen. The Admin password is no longer visible on the touchscreen.
3. Exit the dialog.

Managing Data Usage

On the Web UI Home page, the Data Usage panel displays graphs of your M2000 data usage for the current billing cycle.

The screenshot shows the inseeGo M2000 Web UI Home page. The 'Data Usage' panel is highlighted with a red box. It displays a circular progress indicator at 85% with 8.5 GB of data remaining and 1.5 GB used. The plan is 10.0 GB. Other panels include 'About' (Internet Status: Connected, Network name: <carrier>, Technology: 5G, Time connected: 01 days, 02 hrs, 23 min), 'Connected Devices: 1' (Janeslaptop, Primary), 'Wi-Fi' (Primary Network: ON, Network Name: INS-M2000-38C2, Password: *****), 'Settings' (Mobile Network: ON, Port Filtering: OFF, GPS: OFF, System Update: Last system update: No updates applied), and 'Help' (Overview, Setup, Tips, Security Features, User Guide).

To view the Data Usage page, select **>** from the Home page Data Usage panel (or select **Data Usage** from the Web UI side menu). The Data Usage page appears.

Data Usage Page

Use the Data Usage page to view details about your M2000 data usage and billing plan.

The screenshot displays the 'Data Usage' page for an insee-go M2000 device. The page features a navigation sidebar on the left with options: Home, Data Usage (selected), Wi-Fi, Connected Devices, Settings, About, and Help. The main content area is titled 'Data Usage' and includes a sub-header 'My Plan: 10.0 GB Data Plan' and 'Data Usage: 8.5 GB remaining'. A large circular gauge shows '85%' with '8.5 GB of data remaining' and '8 days to go'. A horizontal bar chart shows '1.5 GB used by device' in blue and '8.5 GB data remaining' in grey. A 'Reset data counter now' button is present. Below the bar chart, there is a dropdown menu for 'Reset data counter on this day of the month' set to '1' and a text input for 'Maximum data limit' set to '10 GB'. A 'Save Changes' button is at the bottom.

The data usage graph displays vary according to plan, but generally include:

- Estimated percentage of data remaining for the current billing cycle
- Number of days left in the billing cycle
- Data limit on your plan
- Estimated amount of data used in the current billing cycle
- Estimated amount of data remaining for the current billing cycle
- Date the billing cycle ends

Reset data counter on this day of the month: Use the drop-down to select a day of the month for the counter displayed on this page to reset.

Maximum data limit: Enter a maximum data limit, if desired.

Select **Save Changes** to enact changes.

Managing Wi-Fi Settings

Your M2000 offers primary and guest networks for accessing the Internet over Wi-Fi. Each network can be accessed over two bands: 2.4 GHz and 5 GHz.

On the Web UI Home page, the Wi-Fi panel shows the current name (SSID) and state of primary and guest networks. Click the eye icon to view the current passwords for each.

The screenshot displays the inseeego M2000 Web UI Home page. The top navigation bar includes the inseeego logo, the model number M2000, a signal strength indicator, 5G connectivity status, a 100% battery icon, and a Sign In button. The main content area is divided into several panels:

- Data Usage:** Shows a circular progress indicator at 85% (8.5 GB of data used, 8.5 GB remaining) and a 'My Plan: 10.0 GB Data Plan' with 8 days to go. A bar chart shows 1.5 GB data used and 8.5 GB data remaining.
- About:** Displays Internet Status (Connected), Network name (<carrier>), Technology (5G), and Time connected (01 days, 02 hrs, 23 min).
- Connected Devices : 1:** A table with columns 'Device' and 'Network'. One device, 'Janeslaptop', is listed under the 'Primary' network.
- Wi-Fi (highlighted with a red box):** Shows Primary Network: ON, Network Name (SSID): INS-M2000-38C2, Password: ***** (with an eye icon to toggle visibility), and Guest Network: OFF.
- Settings:** Shows Mobile Network: ON, Port Filtering: OFF, and GPS: OFF. A System Update notification states 'Last system update: No updates applied.'
- Help:** Provides links for Overview, Setup, Tips, Security Features, and User Guide.

The footer contains the inseeego logo, copyright information (© 2020 All rights reserved.), and the website URL www.inseeego.com.

To manage settings for these networks, select > from the Home page Wi-Fi panel (or select **Wi-Fi** from the Web UI side menu).

The Wi-Fi page includes three tabs:

- Settings
- Primary Network
- Guest Network

Settings Tab

You can use the default values as they appear on this tab, or can adjust them for your environment.

The screenshot shows the 'insee go M2000' settings interface. At the top right, there are status icons for signal strength, 5G, and 100% battery, along with a 'Sign Out' button. A left-hand navigation menu includes 'Home', 'Data Usage', 'Wi-Fi', 'Connected Devices', 'Settings', 'About', and 'Help'. The main content area is titled 'Wi-Fi' and has three tabs: 'Settings', 'Primary Network', and 'Guest Network'. Below the 'Settings' tab, there is a note: 'These settings apply regardless of which network (primary, guest, or both) is in use. Changes made to these Wi-Fi settings may prevent some Wi-Fi devices from connecting.' Under the 'Wi-Fi' section, there are two toggle switches: 'Allow Wi-Fi devices to connect' (turned ON) and 'Allow Wi-Fi setting changes from the touchscreen' (turned ON). Below these is a 'Limit connected devices to:' field set to '30' with a 'Change connection limit' link. The 'Band Selection' section includes a note: 'Note: Making band selection changes may cause both the primary and guest networks turn off and on again. Devices will be disconnected and you need to sign back into the Admin website.' It features two columns for '2.4 GHz Band' and '5 GHz Band'. Under 'Primary network', the 2.4 GHz band is selected. Under 'Guest network', the 5 GHz band is selected. Under 'Off', both bands are unselected. Below this are '2.4 GHz Band Settings' and '5 GHz Band Settings', each with dropdown menus for '802.11 mode', 'Channel', and 'Bandwidth'. A 'Save Changes' button is at the bottom.

Wi-Fi

Use the **Allow Wi-Fi devices to connect ON/OFF** slider to turn Wi-Fi on or off. This selection affects primary and guest networks. **NOTE:** If Wi-Fi is off, the only way to connect devices to the M2000 is by tethering with the USB cable.

Use the **Allow Wi-Fi setting changes from the touchscreen ON/OFF** slider to allow or disallow setting Wi-Fi options on the M2000 touchscreen. This selection affects primary and guest networks.

Select **Change connection limit** to change the maximum number of devices allowed to connect to your M2000 Wi-Fi. Use the slider to select a number and click **Save Changes**. The maximum number of connected devices is 30.

Band Selection

Each network can be accessed over two bands: 2.4 GHz and 5 GHz:

- The 2.4 GHz band is supported by all devices with Wi-Fi and should be used by devices that are a few years old or older. This band passes through walls better and propagates over longer distances, so it may have a longer range.
- The 5 GHz band is best for newer devices. It offers better throughput, reduced interference and faster data speeds, but does not pass through walls as well as the 2.4 GHz band.

NOTE: The guest network must be assigned at least one band before it can be turned on.

2.4 GHz Band Selection

This section displays the 802.11 Mode in use when the 2.4 GHz band is active and allows you to select a Channel.

NOTE: Leave the Channel set to **Automatic** unless you need to choose a particular channel for your environment.

5 GHz Band Selection

This section displays the 802.11 Mode in use when the 5 GHz band is active and allows you to select a Bandwidth and Channel.

Bandwidth: Leave bandwidth at the default setting unless you experience interference with other Wi-Fi devices. If you experience interference, try lowering the setting to reduce the interference.

NOTE: Leave the **Channel** set to **Automatic** unless you need to choose a particular channel for your environment.

Select **Save Changes** to store new settings.

Primary Network Tab

Use these settings to connect initially to the primary Wi-Fi network or change primary network information. Connected devices must use the Wi-Fi settings shown on this screen.

The screenshot shows the 'insee go M2000' interface. At the top right, there are status icons for signal strength, 5G, and battery, along with a 'Sign Out' button. The left sidebar contains navigation options: Home, Data Usage, Wi-Fi (selected), Connected Devices (with a red notification icon), Settings, About, and Help. The main content area is titled 'Wi-Fi' and has three tabs: 'Settings', 'Primary Network' (active), and 'Guest Network'. A note states: 'Note: For added security, share your guest network instead of your primary network.' Below this are three input fields: 'Primary network name (SSID):' with the value 'INS-M2000-38C2', 'Security:' with a dropdown menu set to 'WPA3/WPA2 Transition', and 'Password:' with a masked field and an eye icon. A 'Generate new password' button is located below the password field. Another note says: 'Note: You can create a new password by entering it, or generate a new one. Password must be 8-63 characters. For greater security, use a mixture of digits, upper case, lower case and other symbols.' Below the notes are five checkboxes: 'Hide primary network name (SSID) on the touchscreen' (unchecked), 'Hide password on touchscreen' (unchecked), 'Broadcast primary network name (SSID):' (checked), 'WPS' (checked), and 'Wi-Fi privacy separation' (unchecked). A 'Save Changes' button is at the bottom.

NOTE: If you change these settings, existing connected devices may lose their connection.

Primary network name (SSID): Enter a primary network name (SSID) to set up or change the primary network name. The name can be up to 32 characters long.

Security: Select an option for Wi-Fi security:

- **WPA3/WPA2 Transition** is the most secure method of Wi-Fi Protected Access and should be used if possible for WPA2 and WPA3 compliant devices.
- **WPA2 Personal PSK (AES)** can be used for WPA2 devices.
- **WPA/WPA2 Mixed Mode** can be used if some of your older devices do not support WPA2.
- **None** allows others to monitor your Wi-Fi traffic and use your data plan to access the Internet.

NOTE: Avoid using this option.

Password: Enter a Wi-Fi password, **or** you can use the Generate new password button.

Important: It is critical that you change the password from the default and use a different password from your Admin password to keep the device and your network secure.

Generate new password: This button inserts a strong random password in the Password field.

You can click the eye icon to view the password.

Hide primary network name (SSID) on the touchscreen: Check this box to hide the Wi-Fi primary network name on the M2000 touchscreen. If unchecked, the primary network name is visible on the touchscreen.

Hide password on touchscreen: Check this box to hide the Wi-Fi primary network password on the M2000 touchscreen. If unchecked, the primary network password is visible on the touchscreen.

Broadcast primary network name (SSID): Check this box to display the Wi-Fi primary network in the list of available Wi-Fi networks on your connected devices. If unchecked, this network is not visible to connected devices.

WPS: Check this box to use Wi-Fi Protected Setup (WPS) for the primary network. WPS allows compatible devices to connect to a Wi-Fi network without having to manually enter the password.

Wi-Fi privacy separation: Check this box to keep each connected device on this network isolated from all other connected devices. This provides additional security if some connected devices are unknown or not completely trusted. **NOTE:** For normal operation, this should be unchecked.

Select **Save Changes**.

Guest Network Tab

The Wi-Fi guest network allows you to segregate traffic to a separate network rather than share access to your Wi-Fi primary network. Use settings on this tab to set up or change Wi-Fi guest network information. Connected devices must use the Wi-Fi settings shown on this screen to connect to the guest M2000 Wi-Fi network.

The screenshot shows the 'insee-go M2000' interface. At the top right, there are status icons for signal strength, 5G, and 100% battery, along with a 'Sign Out' button. A left sidebar contains navigation options: Home, Data Usage, Wi-Fi (selected), Connected Devices (with a red notification icon), Settings, About, and Help. The main content area is titled 'Wi-Fi' and has three tabs: 'Settings', 'Primary Network', and 'Guest Network' (which is active). Below the tabs, a note states: 'NOTE: For added security, share your guest network instead of your primary network.' The settings include: 'Guest network name (SSID):' with a text input field containing 'INS-M2000-Guest-38C3'; 'Security:' with a dropdown menu set to 'WPA3/WPA2 Transition'; and 'Password:' with a masked input field and a 'Generate new password' button. Below these are five toggle options: 'Hide guest network name (SSID) on the touchscreen:' (unchecked), 'Hide password on touchscreen:' (unchecked), 'Broadcast guest network name (SSID)' (checked), 'WPS' (checked), and 'Wi-Fi privacy separation' (checked). A 'Save Changes' button is at the bottom.

NOTE: To turn the Wi-Fi guest network on, you must select at least one band for Guest Network under **Band Selection** on the **Wi-Fi Settings** tab and then select **Save Changes**.

Guest network name (SSID): Enter a guest network name (SSID) to set up or change the guest network name. The name can be up to 32 characters long.

Security: Select an option for Wi-Fi security:

- **WPA3/WPA2 Transition** is the most secure method of Wi-Fi Protected Access and should be used if possible for WPA2 and WPA3 compliant devices.
- **WPA2 Personal PSK (AES)** can be used for WPA2 devices.
- **WPA/WPA2 Mixed Mode** can be used if some of your older devices do not support WPA2.
- **None** allows others to monitor your Wi-Fi traffic and use your data plan to access the Internet.

NOTE: Avoid using this option.

Password: Enter a Wi-Fi password, **or** you can use the Generate new password button.

Important: It is critical that you change the password from the default and use a different password from your Admin or primary network password to keep the device and your network secure.

Generate new password: This button inserts a strong random password in the Password field.

You can click the eye icon to view the password.

Hide guest network name (SSID) on the touchscreen: Check this box to hide the Wi-Fi guest network name on the M2000 touchscreen. If unchecked, the guest network name is visible on the touchscreen.

Hide password on touchscreen: Check this box to hide the Wi-Fi guest network password on the M2000 touchscreen. If unchecked, the guest network password is visible on the touchscreen.

Broadcast guest network name (SSID): Check this box to display the Wi-Fi guest network in the list of available Wi-Fi networks on your connected devices. If unchecked, this network is not visible to connected devices.

WPS: Check this box to use Wi-Fi Protected Setup (WPS) for the guest network. WPS allows compatible devices to connect to a Wi-Fi network without having to manually enter the password.

Wi-Fi privacy separation: Check this box to keep each connected device on this network isolated from all other connected devices. This provides additional security if some connected devices are unknown or not completely trusted. **NOTE:** For normal operation, this should be unchecked.

Select **Save Changes**.

Managing Connected Devices

On the Web UI Home page, the Connected Devices panel lists all devices currently connected to your M2000, along with the network they are using.

The screenshot displays the inseeGo M2000 Web UI Home page. At the top left is the inseeGo logo and 'M2000'. At the top right are signal strength, 5G, and battery icons, along with a 'Sign In' button. The main content area is divided into several panels:

- Data Usage:** Shows 'My Plan: 10.0 GB Data Plan' with a circular progress indicator at 85%. It indicates 8.5 GB of data used and 1.5 GB remaining. A '8 days to go' timer is also present.
- About:** Lists 'Internet Status: Connected', 'Network name: <carrier>', 'Technology: 5G', and 'Time connected: 01 days, 02 hrs, 23 min'.
- Connected Devices : 1:** A table with columns 'Device' and 'Network'. It lists 'Janeslaptop' with a 'Primary' network.
- Wi-Fi:** Shows 'Primary Network: ON', 'Network Name (SSID): INS-M2000-38C2', 'Password: *****', and 'Guest Network: OFF'.
- Settings:** Shows 'Mobile Network: ON', 'Port Filtering: OFF', 'GPS: OFF', and 'System Update: Last system update: No updates applied.'
- Help:** Contains links for 'Overview', 'Setup', 'Tips', 'Security Features', and 'User Guide'.

At the bottom, the inseeGo logo, copyright notice '© 2020 All rights reserved.', and website 'www.inseeGo.com' are visible.

To manage connected devices, select > from the Home page Connected Devices panel (or select **Connected Devices** from the Web UI side menu).

Connected Devices Page

This page provides details about each device connected to the M2000 and allows you to edit how device names appear in the Web UI. You can also block or unblock a device from Internet access.

Device	Network	Block
Janeslaptop	USB	<input type="checkbox"/>
Janeslaptop	Primary	<input type="checkbox"/>

[Change Wi-Fi connection limit \(30\)](#)

[Save Changes](#)

Connected Devices

This table lists all devices connected to the M2000:

Device: An icon indicates the connection type (Wi-Fi or USB) for each device. (You can hover over the icon to read the type of connection.) The name of the connected device is usually the hostname set on the connected device. In rare cases, the hostname may be unavailable.

Network: Indicates whether the device is connected to the primary or guest network.

Block: Select this box to disconnect a device and prevent it from reconnecting. Select **Save Changes**. The device is removed from the **Connected** list and appears in the **Blocked** list below.

NOTE: This option is available for each device connected through Wi-Fi, but is not available for your own device or devices connected via USB.

To view details on a device or change the name of the device as it appears in this Web UI, click the **down arrow icon** on the right to expand the device row. The following information appears:

- **Name:** To change how the device name appears in this Web UI, enter a different name. **NOTE:** This only changes the device name in the M2000 Web UI.
- **IPv4:** The IP address of the connected device.
- **MAC Address:** The MAC Address (unique network identifier for this connected device).
- **Link Local:** The Link-Local IPv6 address if the connected device supports IPv6.

Click the **up arrow icon**  to collapse the row.

Select **Change connection limit** to change the maximum number of devices allowed to connect to your M2000 Wi-Fi. Use the slider to select a number and click **Save Changes**. The maximum number of connected devices is 30.

Blocked

This section lists all devices blocked from connecting to the M2000.

NOTE: Since blocked devices are not currently connected, they do not have an IP address. Instead, they are identified by their name and MAC address.

To unblock a blocked device, click the **Unblock** button and select **Save Changes**. The device is removed from the **Blocked** list and appears in the **Connected Devices** list above.

Managing Settings

On the Web UI Home page, the Settings panel shows the current Mobile Network, Port Filtering, and GPS settings (ON/OFF), and the date and time of the last system update.

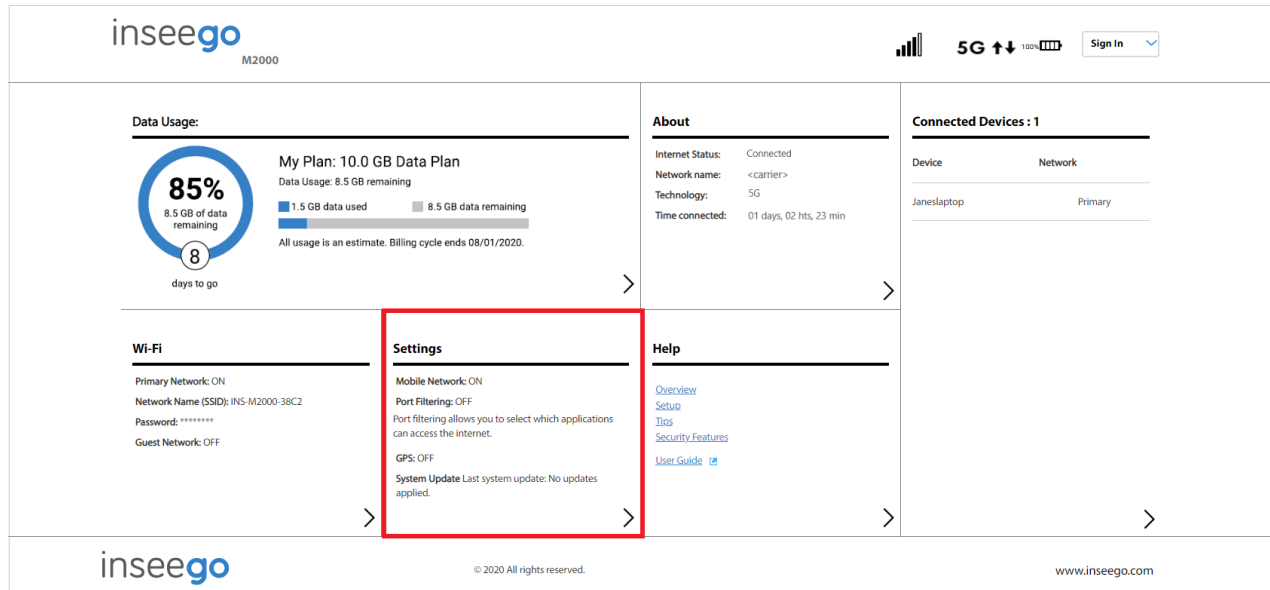

To change system settings, select > from the Home page Settings panel (or select **Settings** from the Web UI side menu).

The Settings page includes five tabs:

- Preferences
- Software Update
- Backup and Restore
- GPS
- Advanced

Preferences Tab

This tab allows you to configure options for the M2000 touchscreen, notification settings, and Web UI display settings.

The Preference tab includes three sub tabs:

- Device Preferences
- Notifications
- User Preferences

Device Preferences Sub Tab

Use this page to set options for the M2000 touchscreen.

The screenshot shows the 'insee go M2000' settings interface. At the top, there's a status bar with signal strength, 5G, and battery level. The main menu on the left includes Home, Data Usage, Wi-Fi, Connected Devices (with a red notification icon), Settings (highlighted), About, and Help. The 'Settings' page has sub-tabs: Preferences (selected), Software Update, Backup and Restore, GPS, and Advanced. Under 'Preferences', there are three sub-sections: Device Preferences (selected), Notifications, and User Preferences. The 'Device Preferences' section includes: 'USB mode when connected to a computer:' set to 'USB charging'; 'Prompt on USB connection:' checked; 'Turn off screen:' set to 'After 30 seconds'; 'Sleep:' set to 'After 5 minutes'; and 'Shutdown:' set to 'Never'. Below this is the 'Universal Charging' section, which includes a note about charging from the MIFI's USB port, a 'Stop Charging when MIFI's battery is at:' dropdown set to '25%', and three toggle switches: 'Current Status:' (Available), 'Allow settings changes from the touchscreen:' (turned on), and 'Allow factory reset from the touchscreen:' (turned on). A 'Save Changes' button is at the bottom.

USB mode when connected to a computer: Use the drop-down list to select the type of connection you want for devices connecting to the M2000 USB-C port: USB charging, Internet access via USB and Wi-Fi, or Internet access via USB only.

Prompt on USB connection: Check this box for a prompt to display on the M2000 screen when a device connects via USB. The prompt allows selection of the USB mode of connection. **NOTE:** A USB mode selection made on the M2000 touchscreen does not change the setting above. The setting above acts as a default, and the choice on the M2000 touchscreen sets the mode for the current USB session only.

Turn off screen: Use the drop-down list to select how long you want the M2000 to be inactive before the touchscreen turns off.

Sleep: Use the drop-down list to select how long you want the M2000 to be inactive before entering sleep mode.

Shutdown: Use the drop-down list to select how long you want the M2000 to be inactive before shutting down.

Universal Charging

Stop charging external device when battery reaches: Use the drop-down list to select a battery percentage for the M2000 at which you want to stop charging other devices in order to reserve M2000 battery power.

Current Status: The current status of universal charging:

Charging – A device is being charged from the M2000 battery.

Available – If a device connects to the M2000 USB-C port, it will be charged.

Not available (low battery) – The M2000 battery is too low to charge a device.

Allow settings changes from the touchscreen: Use the **ON/OFF** slider to allow or disallow configuration of settings on the M2000 touchscreen. **NOTE:** If **ON**, settings can be configured on the M2000 touchscreen, including Factory Reset, which resets all settings to factory default settings and disconnects all connected devices.

Allow factory reset from the touchscreen: Use the **ON/OFF** slider to allow or disallow factory reset from the M2000 RESET button and touchscreen (Settings > Factory Reset). If **ON**, factory reset is allowed from the M2000 RESET button and touchscreen. Factory reset resets all settings to factory default settings and disconnects all connected devices. **NOTE:** If **Allow settings changes from the touchscreen** (above) is OFF, Settings > Factory Reset is not available on the touchscreen, even when this slider is ON.

Notifications Sub Tab

Use this page to set options for notifications on your M2000.

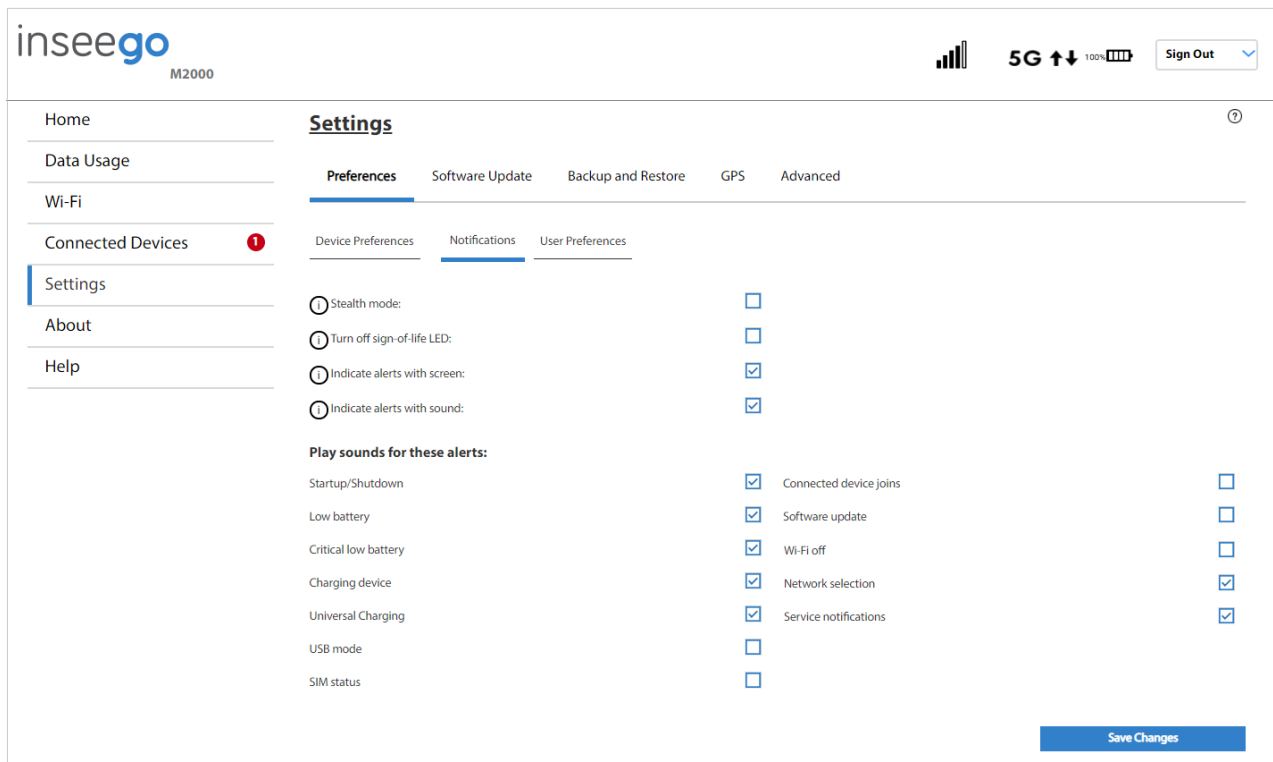

Stealth mode: Check this box to turn off the LED and audio capabilities of your M2000. **NOTE:** If checked, other than the startup process, the M2000 touchscreen turns on only when the Power button is pushed.

Turn off sign-of-life LED: Check this box to turn off the LED status light. When unchecked, the LED blinks slowly as a “sign of life”. This option is grayed out if Stealth mode is on.

Indicate alerts with screen: Check this box to turn on your M2000 touchscreen when an alert message displays. This setting is enabled by default.

Indicate alerts with sound: Check this box to have your M2000 make sounds upon startup, shutdown, and other various events. This setting is enabled by default. This option is grayed out if Stealth mode is on.

Play sounds for these alerts:

Check the boxes for the events you want to trigger an audio alert:

- **Startup/Shutdown**
- **Low battery**
- **Critical low battery**
- **Charging device**
- **Universal charging**
- **USB mode**
- **SIM status**
- **Connected device joins**
- **Software update**
- **Wi-Fi off**
- **Network selection**
- **Service notifications**

NOTE: This section is grayed out if the Stealth mode setting above is checked, or Indicate alerts with sound is unchecked.

User Preferences Sub Tab

Use this page to change how dates, time, and numbers are displayed in the M2000 Admin Web UI.

The screenshot shows the insee go M2000 Admin Web UI. The top navigation bar includes the insee go logo, the device model M2000, signal strength, 5G connectivity, 100% battery, and a Sign Out button. The left sidebar contains navigation links: Home, Data Usage, Wi-Fi, Connected Devices (with a red notification icon), Settings (highlighted), About, and Help. The main content area is titled 'Settings' and has sub-tabs for Preferences, Software Update, Backup and Restore, GPS, and Advanced. Under the 'Preferences' sub-tab, there are further sub-tabs for Device Preferences, Notifications, and User Preferences. The 'User Preferences' sub-tab is active, showing five settings: Language (English), Date (mm/dd/yyyy), Time (12 hr), Distance (Feet), and Number format (3,234.00). A 'Save Changes' button is located at the bottom of the settings list.

Language: Select a language for the Admin Web UI.

Date: Select the date format to be used throughout the Web UI (mm/dd/yyyy or dd/mm/yyyy).

Time: Select the time format to be used throughout the Web UI (12 or 24 hour).

Distance: Select the distance format to be used for the Web UI when marking GPS altitude and accuracy (Feet or Meters).

Number format: Choose the format for decimal numbers displayed in the Web UI (using a period or comma as the decimal point).

Select your display choices from the drop-down menus and click **Save Changes** to update settings.

Software Update Tab

Software updates are delivered to the M2000 automatically over the mobile network. This tab displays your current software version, last system update information, software update history, and allows you to check for new software updates.

The screenshot shows the 'inseeego M2000' settings interface. At the top, there's a status bar with signal strength, 5G, and 100% battery. Below that, a navigation menu on the left includes Home, Data Usage, Wi-Fi, Connected Devices (with a red notification icon), Settings (highlighted), About, and Help. The main content area is titled 'Settings' and has sub-tabs: Preferences, Software Update (selected), Backup and Restore, GPS, and Advanced. Under 'Software Update', there are three sections: 'Current Software' showing version '1H L2.190 MSDX55MOR-1.34 1 [2020-07-16 02:14:28]', 'Check for New Software Update' showing 'Last check for update: Never' and a 'Check for Update' button, and 'Last Software Update' showing 'No updates applied.' At the bottom, 'Software Update History' shows the same version as the current software.

Current Software

Software version: The version of the software currently installed on your M2000.

Check for New Software Update

Last check for update: The date and time the M2000 last checked to see if an update was available.

Update status: This area is usually blank. If you check for an update, the result of that check, or the download progress of an update displays.

Check for Update: Click this button to manually check for available software updates. If a new software update is available, it is automatically downloaded.

Last Software Update

This section displays details about the last software update.

Software Update History

This section displays details of the last updates that have been downloaded and installed to this device. If no updates have been installed, this section displays the current software version.

Backup and Restore Tab

Use this tab to back up current M2000 settings to a file on your computer, restore (upload) a previously-saved configuration file, reset the router to factory defaults, or restart or turn off your M2000.

The screenshot shows the inseeego M2000 web interface. The top navigation bar includes the inseeego logo, signal strength, 5G status, battery level, and a Sign Out button. The left sidebar lists menu items: Home, Data Usage, Wi-Fi, Connected Devices (with a notification icon), Settings (highlighted), About, and Help. The main content area is titled 'Settings' and has sub-tabs for Preferences, Software Update, Backup and Restore (selected), GPS, and Advanced. Under 'Backup and Restore', there are four sections: 1. 'Backup Configurations' with an 'Admin password' field and a 'Download' button. 2. 'Restore Settings' with an 'Admin password' field, a 'Select a file' section with 'No file selected' and 'Browse' buttons, and a 'Restore now' button. 3. 'Restore to Factory Defaults' with a 'Restore factory defaults' button. 4. 'Restart M2000' with a 'Restart' button. 5. 'Turn Off M2000' with a 'Turn off' button.

Backup Configurations

To back up current M2000 settings to a file on your computer, enter your Admin password in the **Admin password** field.

The initial Admin password is the same as the default password for your M2000 primary network. Tap **Wi-Fi Name/Password** on the Home screen of your M2000 to view the password. If you have changed the Admin password and don't remember it, select **Sign Out** in the top-right corner of the Home page, click **I forgot the Admin password**, and answer the displayed security question. The current Admin password will be displayed.

NOTE: If you enter an incorrect password five times in a row, you will be locked out of the Web UI. To unlock it, restart your M2000.

Click the **Download** button. The file is automatically downloaded to your Downloads folder. This configuration file contains all settings for your M2000.

NOTE: The backup file cannot be edited or viewed on the downloaded system or on any other device. This file can only be restored for this model of MiFi.

Restore Settings

CAUTION: Restoring settings (uploading a configuration file) changes ALL of the existing settings to match the configuration file. This may change the current Wi-Fi settings, breaking all existing connections to the M2000 and disconnecting you from the Web UI.

To restore system settings from a backup settings file, enter your Admin password in the **Admin password** field.

In the **Select a file** field, click **Browse** and choose a backup settings file to restore.

NOTE: You can only restore a file that was created for this model of MiFi.

Click the **Restore now** button.

Restore to Factory Defaults

Restore factory defaults: This button resets all settings to their factory default values.

CAUTION: This initiates a restart and may change the current Wi-Fi settings, breaking all existing connections to your M2000 and disconnecting you from the Web UI.

Restart M2000

Restart: This button turns your M2000 off and on again.

Turn off M2000

Restart: This button turns your M2000 off.

GPS Tab

The M2000 incorporates a GPS receiver. The GPS receiver can determine your current location. Use this tab to enable GPS, view current location information, and to enable GPS streaming to devices with the GPS over Wi-Fi feature.

The screenshot shows the inseeego M2000 web interface. The top navigation bar includes 'Home', 'Data Usage', 'Wi-Fi', 'Connected Devices', 'Settings', 'About', and 'Help'. The 'Settings' page is divided into 'Preferences', 'Software Update', 'Backup and Restore', 'GPS', and 'Advanced'. The 'GPS' tab is active, showing 'GPS Settings' with three toggle switches: 'Enable GPS' (ON), 'Turn off GPS when the M2000 restarts' (OFF), and 'Turn on GPS over Wi-Fi' (OFF). A 'Port Number' field is set to '11010' with a 'Save Changes' button below it. The 'GPS Driver' section has a 'Download Driver' button. The 'Current Location' section displays the following data:

Current Location			
Acquired			
Latitude:	43.88198793	Altitude:	952 ft
Longitude:	-123.09447558	Accuracy:	60 ft

GPS Settings

Enable GPS: This setting enables or disables the GPS radio on your M2000. When the **ON/OFF** slider is **ON**, the device acquires GPS and makes GPS location data available on this page. A GPS Agreement appears, click **Confirm** to proceed. When **OFF**, no GPS data is available.

Turn off GPS when the M2000 restarts: This setting determines when the GPS receiver will turn off, once it is on. When the **ON/OFF** slider is **ON**, the GPS receiver turns off when the M2000 is shut down. You will need to turn it on again the next time the GPS receiver is needed.

Turn on GPS over Wi-Fi: Allows you to share location information with connected devices. Raw GPS data is provided in the form of a National Marine Electronics Association (NMEA) text stream. You can use third-party applications to utilize or forward the GPS data to a remote server. When the **ON/OFF** slider is **ON**, location information can be shared.

Port Number: The TCP port number used to establish a connection to the M2000 and obtain raw GPS data for the GPS over Wi-Fi feature. Unless there is a good reason to do so, you should not change the port number. Acceptable port values are between 1024 and 65535.

GPS Driver

For the GPS over Wi-Fi feature, if you want to access the GPS data stream from a virtual COM port instead of the TCP port (above), use the **Download Driver** button to download and install a GPS driver for your Windows platform. This driver creates a virtual NMEA port, obtains GPS data from the M2000, and makes this GPS data available to NMEA-aware third-party applications.

Current Location

Latitude: Latitude for the last location fix.

Longitude: Longitude for the last location fix.

Altitude: Altitude for the last location fix.

Accuracy: A measure of the accuracy of the horizontal position obtained by the GPS receiver.

NOTE: You can change the format of measurement (Feet or Meters) in **Settings > Preferences > User Preferences**.

Advanced Tab

Advanced settings are intended only for users with advanced technical knowledge. For information about the Advanced Settings page, go to Chapter 4, Advanced Settings on page 64.

Viewing Info About the M2000

On the Web UI Home page, the About panel shows current Internet status, the name of the network to which the M2000 is connected, technology, and amount of time connected.

The screenshot displays the inseeGo M2000 Web UI Home page. The 'About' panel is highlighted with a red border. The page is divided into several sections:

- Data Usage:** Shows a circular progress indicator at 85% (8.5 GB of data used, 8.5 GB remaining) and a 'My Plan: 10.0 GB Data Plan' with 8.5 GB data used and 8.5 GB data remaining. A bar chart shows 1.5 GB data used and 8.5 GB data remaining. A note states: 'All usage is an estimate. Billing cycle ends 08/01/2020.' Below this is a 'days to go' indicator with the number 8.
- About:** (Highlighted with a red border) Shows: Internet Status: Connected; Network name: <carrier>; Technology: 5G; Time connected: 01 days, 02 hrs, 23 min.
- Connected Devices: 1:** A table with columns 'Device' and 'Network'. One device is listed: 'Janeslaptop' with 'Primary' network.
- Wi-Fi:** Shows Primary Network: ON; Network Name (SSID): INS-M2000-38C2; Password: *****; Guest Network: OFF.
- Settings:** Shows Mobile Network: ON; Port Filtering: OFF; GPS: OFF; System Update: Last system update: No updates applied.
- Help:** Includes links for Overview, Setup, Tips, Security Features, and User Guide.

The footer contains the inseeGo logo, copyright notice '© 2020 All rights reserved.', and the website URL 'www.inseeGo.com'.

To view more detailed information about your M2000 and its use, select > from the Home page About panel (or select **About** from the Web UI side menu).

The About page includes four tabs:

- Internet Status
- Diagnostics
- Device Info
- Logs

Internet Status Tab

Use the Internet Status tab to view general Internet connection and system information.

The screenshot shows the inseeego M2000 interface. At the top left is the logo 'inseeego M2000'. At the top right are icons for cellular signal strength, '5G' with up/down arrows, a 100% battery icon, and a 'Sign Out' button with a dropdown arrow. A left sidebar contains navigation links: Home, Data Usage, Wi-Fi, Connected Devices (with a red notification icon), Settings, About (highlighted with a blue bar), and Help. The main content area is titled 'About' and has a sub-tab 'Internet Status' selected. Below this are three sections: 'General', 'IPv4', and 'IPv6'. The 'General' section lists: Status: Connected; Network Name: T-Mobile; Technology: 5G; Time Connected: 01:16:35:45 (dd:hh:mm:ss); Received: 4.55 GB; Transmitted: 5.56 GB. The 'IPv4' section lists: IP Address: 110.183.21.139; Mask: 255.255.255.255; Gateway: 10.183.21.139; DNS: 66.174.92.14. The 'IPv6' section lists: IP Address: xxxxxxxxxxxxxxxxxxxxxx.

General

Status: The current status of the M2000 Internet connection.

Network Name: The name of the network for the current Internet session established.

Technology: Indicates the current cellular data connection, for example, 5G.

Time Connected: The amount of time that has elapsed since the connection for the current Internet session was established.

Received: The amount of data received for the current Internet session. This counter starts at zero when the connection is established.

Transmitted: The amount of data transmitted for the current Internet session. This counter starts at zero when the connection is established.

IPv4

- **IP Address:** The Internet IP address assigned to the M2000.
- **Mask:** The network mask associated with the IPv4 address.
- **Gateway:** The gateway IP address associated with the IPv4 address.
- **DNS:** The Domain Name Server currently used by the M2000.

IPv6

- **IP Address:** The global IPv6 address for the M2000 (blank if IPv6 is turned off or is not supported by the current network connection or operator).

Diagnostics Tab

This tab displays detailed information used solely for troubleshooting or technical support.

The screenshot shows the 'insee go' app interface for an M2000 device. The top navigation bar includes the logo, 'M2000', signal strength, '5G' status, battery level at 100%, and a 'Sign Out' button. A left sidebar contains menu items: Home, Data Usage, Wi-Fi, Connected Devices (with a red notification icon), Settings, About (highlighted), and Help. The main content area is titled 'About' and has sub-tabs for 'Internet Status', 'Diagnostics' (selected), 'Device Info', and 'Logs'. Under 'Diagnostics', there are two sections: 'Modem' and 'Network'. The 'Modem' section lists: Mobile number (MDN): 319.784.8347, IMEI: 9900 1625 0011 655, IMEISV: 9900 1625 0011 6501, FW Version: SDX55MOR-1.34.1 [2020-07-16 02:14:28], SIM Status: Ready, and ICCID: 89015809000217697361. The 'Network' section lists: Status: Connected, Network Operator: <carrier>, Signal Strength: -95 dBm, SNR: 12 dB, Band: 4, 12, and Roaming: No.

Modem

Mobile number (MDN): The phone number of your M2000.

IMEI: The International Mobile Equipment Identity (IMEI) for your M2000. This is a 15 digit code used to uniquely identify an individual mobile station. The IMEI does not change when the SIM is changed.

IMEISV: A combination of the IMEI and an approval number for this type of device.

FW Version: The version of the firmware (software) currently installed on your M2000.

SIM Status: Indicates the status of the SIM card. If the SIM card is missing, or there is some form of SIM error, connection to the mobile network is not possible.

ICCID: The unique ID number assigned to the SIM card. This field is blank if there is no SIM card installed, or a SIM error condition exists.

Network

Status: The status of the network: Not available or Available.

Network Operator: The name of the Mobile Network Operator (MNO).

Signal Strength: The strength of the cellular signal, measured in dBm. Higher absolute values indicate a stronger signal, for example: -80 dBm is a stronger signal than -90 dBm.

SNR: Signal to Noise Ratio. A measure of the ratio between signal strength and noise level. SNR values are positive, and higher numbers are better.

Band: The band in use for the current connection.

Roaming: Indicates whether roaming is on.

Device Info Tab

Use this tab to view details about your internal WAN connection.

The screenshot shows the Inseego M2000 settings application. At the top left is the 'inseego M2000' logo. At the top right are status icons for signal strength, 5G connectivity, and 100% battery, along with a 'Sign Out' button. A left-hand navigation menu includes: Home, Data Usage, Wi-Fi, Connected Devices (with a red notification badge), Settings, About (highlighted with a blue bar), and Help. The main content area is titled 'About' and has sub-tabs for 'Internet Status', 'Diagnostics', 'Device Info' (selected), and 'Logs'. Under the 'Device Info' tab, there are two sections: 'General' and 'Software Components'. The 'General' section lists: Manufacturer: Inseego, Model: M2000, Hardware Version: 4, and Device Version: 1H. The 'Software Components' section lists: OS Version: 2.190, Modem Firmware Version: SDX55MOR-1.34.1 [2020-07-16 02:14:28], Wi-Fi Firmware Version: 1.0.1.2.136.0, Web UI Version: 2.190.0000, Display UI Version: 2.190.0000, and PRI Version: 129.

General

Manufacturer: Inseego.

Model: M2000.

Hardware Version: The version of hardware.

Device Version: The version of firmware (software) currently installed.

Software Components

OS Version: The version number for the Operating System and its components.

Modem Firmware Version: The version of firmware (software) currently installed for the modem component.

Wi-Fi Firmware version: the version of firmware (software) currently installed for the Wi-Fi component.

Web UI Version: The version number for the M2000 Admin Web UI.

Display UI Version: The version number for the software controlling the M2000 touchscreen.

PRI Version: The configuration version currently applied to the M2000.

Logs Tab

Use this tab to view log information for troubleshooting.

The screenshot shows the inseeo M2000 interface. On the left is a navigation menu with options: Home, Data Usage, Wi-Fi, Connected Devices (with a red notification icon), Settings, About (selected), and Help. The main content area is titled 'About' and has sub-tabs for Internet Status, Diagnostics, Device Info, and Logs (selected). Under the 'Logs' tab, there is a 'Log Settings' section. It includes a 'Turn On Logging' checkbox which is checked, and an 'Automatically clear logs' dropdown menu set to 'After 3 days'. A note below states: 'Note: If the system log is full, then the oldest data is discarded, regardless of this setting.' Below the settings are two tabs: 'Mobile Network Log' (selected) and 'Device Log'. The log data is displayed in a scrollable area with the following entries:

```
Jan 15 20:39:48 (none) modem2d: [MDM_MAIN]:[notice] - (mifios_wanevent): INTERNET IPV4 Call state idle
Jan 15 20:39:48 (none) modem2d: [MDM_MAIN]:[notice] - (mifios_wanevent): INTERNET IPV6 Call state idle
Jan 15 20:39:48 (none) modem2d: [MDM_MAIN]:[notice] - (mifios_wanevent): INTERNET IPV4 Connected!!
Jan 15 20:39:48 (none) modem2d: [MDM_MAIN]:[notice] - (mifios_wanevent): INTERNET IPV4 PDPCONTEXT address:108.123.181.10
Jan 15 20:39:48 (none) modem2d: [MDM_MAIN]:[notice] - (mifios_wanevent): INTERNET IPV4 PDPCONTEXT gateway address:108.123.181.9
Jan 15 20:39:48 (none) modem2d: [MDM_MAIN]:[notice] - (mifios_wanevent): INTERNET IPV4 PDPCONTEXT subnet mask :255.255.255.252
Jan 15 20:39:48 (none) modem2d: [MDM_MAIN]:[notice] - (mifios_wanevent): INTERNET IPV4 PDPCONTEXT DNS1 address:68.28.31.30
Jan 15 20:39:48 (none) modem2d: [MDM_MAIN]:[notice] - (mifios_wanevent): INTERNET IPV4 PDPCONTEXT DNS2 address:68.28.31.31
Jan 15 20:39:48 (none) modem2d: [MDM_MAIN]:[notice] - (mifios_wanevent): INTERNET IPV4 PDPCONTEXT MTU:1500
Jan 15 20:40:03 (none) modem2d: [MDM_MAIN]:[notice] - (mifios_wanevent): INTERNET IPV6 Connected!!
Jan 15 20:40:03 (none) modem2d: [MDM_MAIN]:[notice] - (mifios_wanevent): INTERNET IPV6 PDPCONTEXT address:2600:1:b021:dab1:a876:75ae:7953:9d77
Jan 15 20:40:03 (none) modem2d: [MDM_MAIN]:[notice] - (mifios_wanevent): INTERNET IPV6 PDPCONTEXT gateway address:2600:1:b021:dab1:b5b5:599:4b69:edf0
Jan 15 20:40:03 (none) modem2d: [MDM_MAIN]:[notice] - (mifios_wanevent): INTERNET IPV6 PDPCONTEXT DNS1 address:2600:0:cf02:ffff:68:28:31:30
Jan 15 20:40:03 (none) modem2d: [MDM_MAIN]:[notice] - (mifios_wanevent): INTERNET IPV6 PDPCONTEXT DNS2 address:2600:0:cf02:ffff:68:28:31:31
Jan 15 20:40:03 (none) modem2d: [MDM_MAIN]:[notice] - (mifios_wanevent): INTERNET IPV6 PDPCONTEXT MTU: 1500
```

At the bottom of the log area are four buttons: 'Refresh', 'Clear log', 'Save Changes', and 'Export log'.

Log Settings

Turn on Logging: Check this box to turn on logs as needed.

Automatically clear logs: Use the drop-down list to select when logs are cleared. **NOTE:** If the log is full, the oldest data is deleted regardless of this setting.

Click **Save Changes** to enact changes.

If logs are turned on, the following are visible:

Click on **Mobile Network Log** for log data of connections to the mobile network.

Click on **Device Log** for log data of events other than mobile data connections that occurred on this device.

Refresh: Updates the displayed log data.

Clear log: Deletes all existing log data. This makes new data easier to read.

Export log: Allows you to export log data.

Getting Help

On the Web UI Home page, the Help panel provides links to introductory help and support.

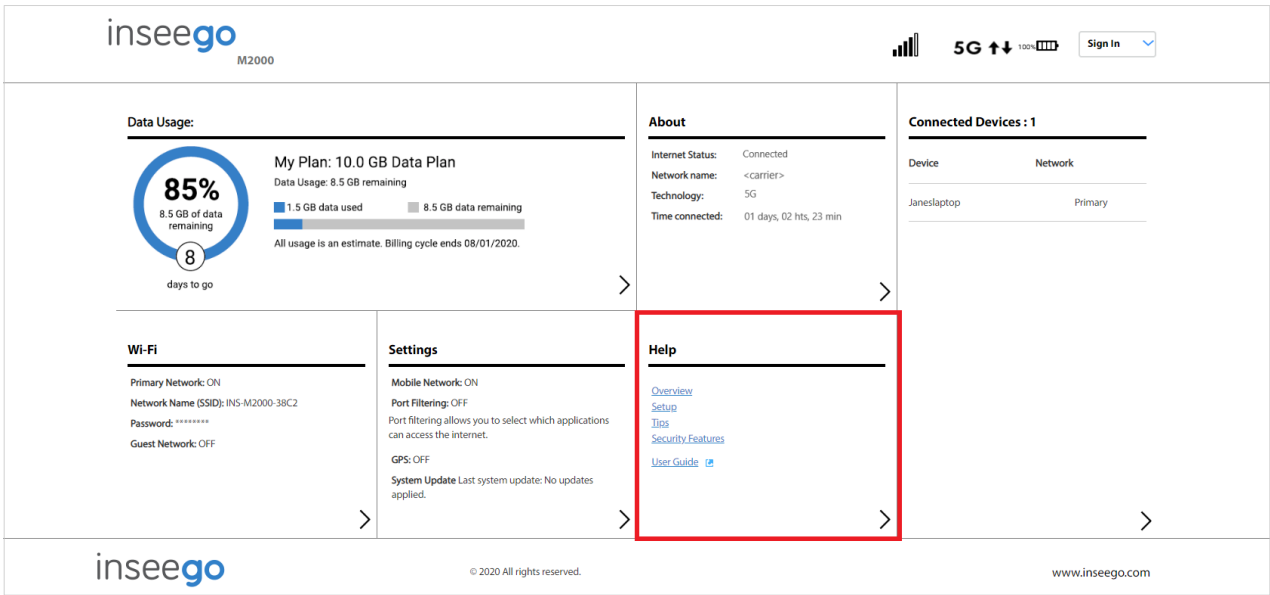

To view more detailed help information, select > from the Home page Help panel (or select **Help** from the Web UI side menu).

The Help page includes two tabs:

- Help
- Customer Support

Help Tab

This page provides links to help topics for every page of the Admin Web UI and general topics useful for getting started with your M2000.

The screenshot shows the inseeego M2000 Admin Web UI. At the top left is the inseeego logo with 'M2000' below it. At the top right are status icons for signal strength, 5G, and 100% battery, along with a 'Sign Out' button. The left navigation menu includes: Home, Data Usage, Wi-Fi, Connected Devices (with a red notification icon), Settings, About, and Help (which is highlighted). The main content area is titled 'Help' and 'Customer Support'. It is divided into three sections: 'Using Your M2000' (Overview, Setup, Tips, Security Features), 'Admin Website Help' (Admin Password, Data Usage, Wi-Fi - Settings, Wi-Fi - Primary Network, Wi-Fi - Guest Network, Connected Devices, Device Preferences, Notification, User Preferences, Software Update, Backup and Restore, GPS, About - Internet status, About - Diagnostics, About - Device info, About - Logs), and 'Advanced' (Networks, Manual Network Selection, Manual DNS, SIM, Firewall, MAC Filter, LAN, Port Filtering, Port Forwarding, VPN).

Customer Support Tab

Use the Customer Support tab for useful links and support information.

The screenshot shows the inseeego M2000 Admin Web UI. At the top left is the inseeego logo with 'M2000' below it. At the top right are status icons for signal strength, 5G, and 100% battery, along with a 'Sign Out' button. The left navigation menu includes: Home, Data Usage, Wi-Fi, Connected Devices (with a red notification icon), Settings, About, and Help (which is highlighted). The main content area is titled 'Help' and 'Customer Support'. It is divided into two sections: 'Your MiFi' and 'Customer Support'. 'Your MiFi' includes: Model (M2000), Your Wireless Number (xxx.xxx.xxx), User Guide ([MiFi M2000 User Guide](#)), and Manufacturer (www.inseeego.com). 'Customer Support' includes: Online Support (www.inseeego.com/support-documentation), Telephone - Domestic (xxx.xxx.xxx), and Telephone - International (+1.xxx.xxx.xxx).

4

Advanced Settings

Overview

Using Advanced Settings

Overview

The Advanced Settings pages on the M2000 Admin website are intended for users with technical expertise in the area of telecommunication and networking.

WARNING! Changing the Advanced settings may be harmful to the stability, performance, and security of the M2000.

Using Advanced Settings

When you select the **Advanced** tab on the Settings page, a warning message appears. If you click **Continue**, the Network tab of the Advanced Settings page appears.

The Advanced Settings page includes ten tabs:

- Networks
- Manual DNS
- SIM
- Firewall
- MAC Filter
- LAN
- Port Filtering
- Port Forwarding
- VPN
- Inseego Connect

Networks Tab

In most configurations, the M2000 is used with a dynamic IP and SIM and the Access Point Name (APN) is available from the network, for example: *internet*. However, if you are on a private network, you may need to set the APN on this tab for the network to communicate with the M2000.

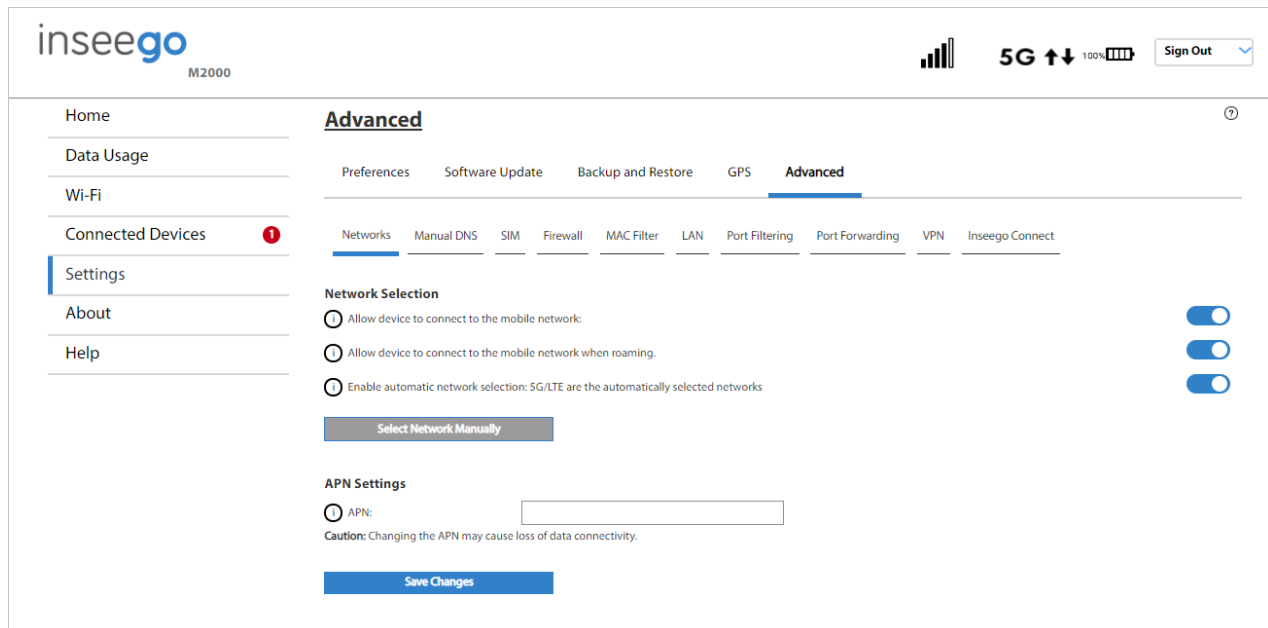

Network Selection

Allow device to connect to the mobile network: Use the **ON/OFF** slider when necessary to turn off cellular data and prevent access to the mobile network. This prevents connected devices from connecting to the Internet and using your M2000 mobile data plan. For normal operation, this setting must be left on.

Allow device to connect to the mobile network when roaming: Use the **ON/OFF** slider to turn off cellular data and prevent access to the mobile network when roaming.

Enable automatic network selection: When the **ON/OFF** slider is **ON**, your M2000 automatically selects the best 5G available network and you cannot use **Select Network Manually** below.

Select Network Manually: You may wish to use this option if multiple networks are available and you have a preference. **NOTE:** This option is available only if **Enable automatic network selection** is off. Click the button to scan for available networks, then choose the preferred network.

APN Settings

Enter the APN for your private network.

CAUTION: Changing the APN may cause a loss of data connectivity and disconnect you from the Web UI.

Click **Save Changes**. The M2000 will reboot for changes to take effect.

Manual DNS Tab

The M2000 automatically selects a Domain Name Server (DNS). This tab allows you to manually assign up to two DNS IP addresses.

The screenshot shows the insee-go M2000 web interface. At the top left is the insee-go logo and 'M2000'. At the top right are icons for signal strength, 5G, and battery level (100%), along with a 'Sign Out' button. A left sidebar contains navigation links: Home, Data Usage, Wi-Fi, Connected Devices (with a red notification icon), Settings (highlighted), About, and Help. The main content area is titled 'Advanced' and has sub-tabs: Preferences, Software Update, Backup and Restore, GPS, and Advanced (selected). Below these are more sub-tabs: Networks, Manual DNS (selected), SIM, Firewall, MAC Filter, LAN, Port Filtering, Port Forwarding, VPN, and Insee-go Connect. The 'Manual DNS' section contains the text: 'Your MiFi automatically selects a Domain Name Server (DNS) or you can manually set one.' Below this is a checkbox for 'Turn on manual DNS:'. Underneath are two input fields: 'DNS 1 IP address:' with a placeholder 'Required (IPv4 or IPv6 address)' and 'DNS 2 IP address:' with a placeholder 'Optional (IPv4 or IPv6 address)'. At the bottom is a blue 'Save Changes' button.

Turn on manual DNS: Check this box to manually select a DNS.

DNS 1 IP address: Enter the IP address for the primary DNS. This address is required to use the Manual DNS feature.

DNS 2 IP address: Enter the IP address for the secondary (backup) DNS. This address is optional and may be left blank if desired.

Click **Save Changes**.

SIM Tab

The SIM card in your M2000 can be locked using a PIN. If the SIM card is locked, you must enter the PIN before connecting to the mobile network. Once entered, the PIN is remembered until the next shutdown. You may also need to provide the existing PIN to change a SIM. The default PIN is available from your service provider.

Use this page to unlock your SIM or enter a SIM PIN.

The screenshot shows the 'inseeego M2000' settings interface. At the top right, there is a signal strength indicator, '5G' with up and down arrows, a 100% battery icon, and a 'Sign Out' button. The left sidebar contains navigation options: Home, Data Usage, Wi-Fi, Connected Devices (with a red notification icon), Settings (highlighted), About, and Help. The main content area is titled 'Advanced' and includes sub-tabs: Preferences, Software Update, Backup and Restore, GPS, and Advanced (selected). Below these are further sub-tabs: Networks, Manual DNS, SIM (selected), Firewall, MAC Filter, LAN, Port Filtering, Port Forwarding, VPN, and Inseeego Connect. The SIM settings section includes a warning: 'For additional security, the SIM card inside your device can be locked with a PIN code. When locked, the PIN code must be entered before the device will connect to the internet.' It features three settings: 'SIM PIN Lock' set to 'Off', 'SIM status' set to 'Ready', and 'Desired Action' set to 'Turn on PIN Lock'. There is an empty input field for 'Current PIN:' and a red warning: '3 attempts remain until your SIM is permanently locked.' A note at the bottom states: 'Note: Entering an incorrect PIN too often will permanently lock your SIM and you will be unable to use the device. You will need to contact customer support to unlock the SIM.' A 'Save Changes' button is at the bottom.

SIM PIN Lock: Indicates whether the PIN lock feature is in use. If On, the PIN lock has been turned on, and the SIM PIN must be entered to connect to the mobile network. If Off, the PIN lock feature is not turned on and the SIM PIN is not required.

SIM status: The current status of the SIM card. Possible states include:

- **Ready** – No SIM PIN is needed.
- **PIN Locked** - SIM PIN must be entered before you can use the mobile network.
- **PUK Locked** - PUK (personal unblocking key) for the SIM must be entered in order to continue. The PUK can be obtained from your service provider.
- **Unlocked** - SIM PIN was needed, but has already been entered.
- **No SIM** - No SIM is detected. Check that the SIM is inserted correctly.
- **SIM Error** - SIM is detected, but is not responding as expected and cannot be used.

Desired Action: The actions available depend on the SIM status. Possible operations include:

- **PIN Lock** - If the SIM is currently PIN locked, you are prompted to enter the PIN.
NOTE: If an incorrect PIN is entered too many times, the SIM becomes PUK locked. A counter indicates how many incorrect entries will cause PUK lock. Once PUK locked, the PUK must be obtained from your service provider.
- **PUK Lock** - If the SIM is currently PUK locked, the only operation possible is to enter the PUK.
NOTE: If an incorrect PUK is entered too many times, the SIM becomes permanently unusable. You will need to obtain a new SIM. A counter indicates how many entry attempts remain.
- **Turn on PIN Lock** - Sets the SIM so that entry of a PIN is required upon startup to connect to the mobile network. To perform this operation, you must enter the current PIN.
- **Turn off PIN Lock** - Turns off a PIN lock that was previously turned on so that entry of a PIN is no longer required to connect to the mobile network. To perform this operation, you must enter the current PIN.

Current PIN: Enter the current PIN.

NOTE: The default SIM PIN is available from your service provider.

Click **Save Changes**.

Firewall Tab

The M2000 firewall determines which Internet traffic is allowed to pass between the M2000 and connected devices and protects your connected devices from malicious incoming traffic from the Internet. The firewall cannot be turned off. Use the Firewall tab to adjust the general security level of the firewall, designate a specific device to receive all traffic, and set up specific firewall rules.

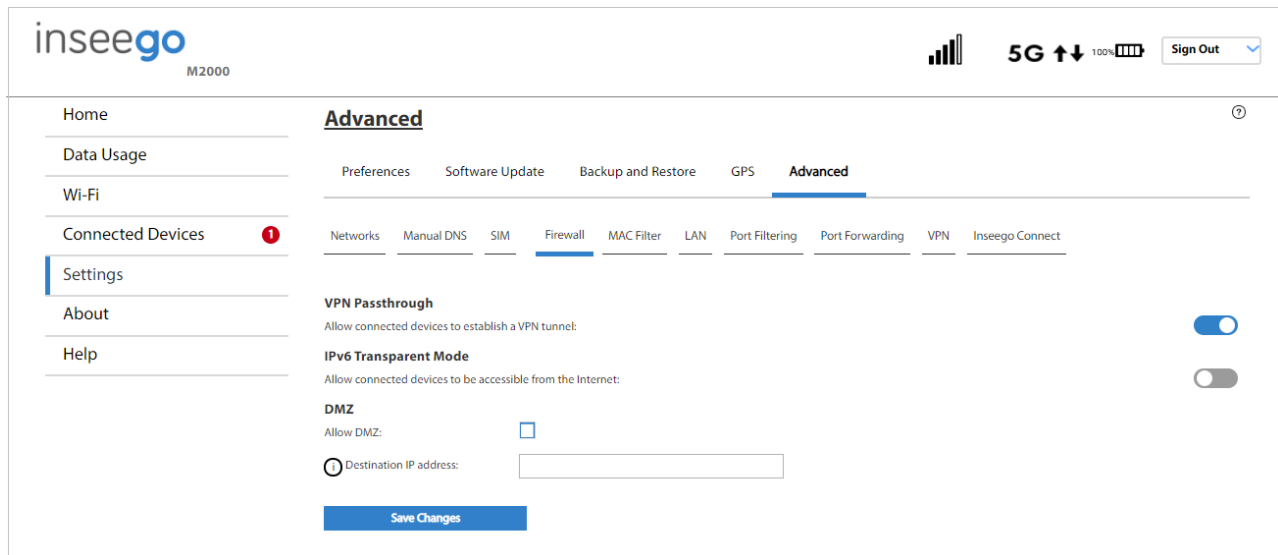

VPN Passthrough

To use the **VPN Passthrough**, ensure the **ON/OFF** slider is **ON**. This allows you to establish a VPN tunnel while using your M2000.

IPv6 Transparent Mode

To use **IPv6 Transparent Mode**, move the **ON/OFF** slider to **ON**. This allows connected devices to be accessible from the Internet.

DMZ

DMZ allows the connected device specified as the DMZ IP address (Destination IP address) to receive all traffic that would otherwise be blocked by the firewall.

NOTE: Allowing DMZ may assist some troublesome network applications to function properly, but the DMZ device should have its own firewall to protect itself against malicious traffic.

Allow DMZ: Check this box to allow DMZ.

Destination IP address: Enter the IP address of the connected device you wish to become the DMZ device (the DMZ destination). **NOTE:** You can check the IP address of each connected device on the Connected Devices screen.

Click **Save Changes**.

Mac Filter Tab

The MAC filter allows only selected devices to access the M2000 primary Wi-Fi network. By default, MAC filter is turned OFF.

Use this tab to turn the MAC Filter ON and specify device access.

The screenshot shows the inseeGo M2000 settings interface. The 'Advanced' tab is active, and the 'MAC Filter' option is selected. The MAC filter is currently turned OFF. A table lists two devices: 'Janeslaptop' with MAC address b4:6b:fc6c:d9:64 (status: Your device) and 'Janeslaptop' with MAC address 00:15:ff:00:11:65 (status: Offline). Both have unchecked 'MAC Address Filter' checkboxes. Buttons for 'Add new device', 'Refresh list', and 'Save Changes' are visible at the bottom.

NOTE: The MAC filter has no effect on devices connected to the guest Wi-Fi network or devices connected via USB.

MAC Filter

To use the MAC filter, select the device(s) from the device list that you want to be allowed to connect to the primary network and move the **ON/OFF** slider to **ON**. Click **Save Changes**.

CAUTION: Turning on MAC filtering immediately disconnects all devices that are not included in the filter from the primary network.

Device List

This list includes all devices currently connected to the M2000, except those connected via USB.

Add new device: Use this button to add a device to the device list, then enter the device name, MAC address, choose whether to select the MAC Address Filter checkbox, and click **Save Changes**.

To delete a device from the list, select its **Delete** checkbox and click **Save Changes**.

To discard any unsaved changes and refresh the list, click **Refresh list** and **Confirm**.

Notes on Blocking Devices

There are two ways to block devices from connecting to the M2000:

- **Temporarily block a device from connecting to the M2000 via the primary and guest networks and via USB.**

To use this method, go to the **Connected Devices** page and click the **Block** button next to the device.

- **Permanently block a device from connecting to your M2000 primary network only.**

Use the **MAC Filter**.

When blocking devices, the following information applies:

- Devices blocked with **Connected Devices > Block** are blocked from the Wi-Fi network, even if the **MAC Filter** is ON and the device is enabled for the MAC Filter.
- If the **MAC Filter** is ON, and a device is blocked with **Connected Devices > Block**, and is not enabled for the MAC Filter, then it will not be able to connect. Both the MAC Filter and the Block prevent connection.
- If the **MAC Filter** is ON, and a device is enabled for the MAC Filter, then the device will be able to connect. However, it can still be blocked using **Connected Devices > Block** or by disabling the **MAC Filter**.

LAN Tab

This tab provides settings and information about the M2000 local area network (LAN). The LAN consists of the M2000 and all Wi-Fi and USB connected devices.

The screenshot shows the inseeo M2000 settings interface. The top navigation bar includes the inseeo logo, signal strength, 5G connectivity, and a 'Sign Out' button. The left sidebar lists navigation options: Home, Data Usage, Wi-Fi, Connected Devices (with a red notification icon), Settings (highlighted), About, and Help. The main content area is titled 'Advanced' and contains sub-tabs: Preferences, Software Update, Backup and Restore, GPS, and Advanced (selected). Under the 'Advanced' sub-tab, there are further sub-tabs: Networks, Manual DNS, SIM, Firewall, MAC Filter, LAN (selected), Port Filtering, Port Forwarding, VPN, and Inseeo Connect. The 'LAN' sub-tab is divided into 'IPv4' and 'IPv6' sections. The IPv4 section includes input fields for IP Address (192.168.1.1), Subnet Mask (255.255.255.0), and MAC Address (28:80:a2:af:38:c2). It also features a checked checkbox for 'Turn on DHCP Server', a 'DHCP Lease Time' of 1440 minutes, and 'Start DHCP Address Range at' (192.168.1.2) and 'End DHCP Address Range at' (192.168.1.102) fields. The IPv6 section has a checked checkbox for 'Turn on IPv6' and a 'Link-Local Address' of fe80:3446:abff:feba:8799. A blue 'Save Changes' button is located at the bottom of the settings area.

IPv4

IP Address: The IP address for your M2000, as seen from the local network. Normally, you can use the default value.

Subnet Mask: The subnet mask network setting for the M2000. The default value 255.255.255.0 is standard for small (class "C") networks. If you change the LAN IP Address, make sure to use the correct Subnet Mask for the IP address range of the LAN IP address.

MAC Address: (read-only) The Media Access Controller (MAC) Address for the Wi-Fi interface on your M2000. The MAC address is a unique network identifier assigned when a network device is manufactured.

Turn on DHCP Server: This checkbox turns the DHCP Server feature on or off. This should be left checked. The DHCP server allocates an IP address to each connected device. **NOTE:** If the DHCP Server is turned off, each connected device must be assigned a fixed IP address.

DHCP Lease Time: The number of minutes in which connected devices must renew the IP address assigned to them by the DHCP server. Normally, this can be left at the default value, but if you have special requirements, you can change this value.

Start DHCP Address Range at: The start of the IP address range used by the DHCP server. If the IP is set on the client device, use an IP address outside of this DHCP range; if the IP address is set using an IP reservation, it will usually be inside this range. **NOTE:** Only expert users should change this setting.

End DHCP Address Range at: The end of the IP address range used by the DHCP server. If the IP is set on the client device, use an IP address outside of this DHCP range; if the IP address is set using an IP reservation, it will usually be inside this range. **NOTE:** Only expert users should change this setting.

IPv6

Turn on IPv6: Check this box if any of your connected devices support IPv6. This enables IPv6 connected devices to make IPv6 connections to the Internet.

Link-Local Address: The Link-Local IPv6 address if the connected device supports IPv6.

Click **Save Changes** to activate and save new settings.

Port Filtering Tab

Port Filtering allows you to block outgoing Internet connections and permit only selected applications to access the Internet. Traffic is identified by port numbers. Some applications are pre-defined. You can define additional applications if you know the details of the traffic used and generated by the applications.

NOTE: You can also view the current Port Filtering setting (ON/OFF) in the Settings panel on the Web UI Home page.

The screenshot shows the Inseego M2000 Web UI. The top navigation bar includes the Inseego logo, signal strength, 5G status, battery level, and a Sign Out button. The left sidebar contains navigation links: Home, Data Usage, Wi-Fi, Connected Devices (with a red notification icon), Settings (highlighted), About, and Help. The main content area is titled 'Advanced' and contains sub-tabs: Preferences, Software Update, Backup and Restore, GPS, and Advanced (selected). Under the 'Advanced' sub-tab, there are further sub-tabs: Networks, Manual DNS, SIM, Firewall, MAC Filter, LAN, Port Filtering (selected), Port Forwarding, VPN, and Inseego Connect. The Port Filtering section includes a toggle switch currently set to 'OFF'. Below the toggle, there is a section for 'Applications' with a list of pre-defined applications: Email (POP3, IMAP, SMTP), FTP, HTTP, HTTPS, and Telnet, each with an unchecked checkbox. A 'Custom Applications' section follows, with a note explaining that users can define their own applications and a button to 'Add custom application'. At the bottom, there is a 'Save Changes' button.

Port Filtering

To turn on port filtering, move the **ON/OFF** slider to **ON**.

To turn off port filtering, so that any application can connect to the Internet, move the slider to **OFF**.

Applications

Select the applications you want to be able to access the Internet and click **Save Changes**.

The following table provides port numbers and protocol information for each port filtering application listed.

Application Name	Port	TCP*	STCP*	UDP*
Email				
POP3	110	Yes	No	Assigned
POP3S	995	Yes	No	Yes
IMAP	143	Yes	No	Assigned
IMAPS	993	Yes	No	Assigned
SMTP	25	Yes	No	Assigned
SecureSMTP	465	Yes	No	No
FTP control (command)	21	Yes	Yes	Assigned
FTP data transfer	20	Yes	Yes	Assigned
HTTP	80	Yes	Yes	Assigned
HTTPS	443	Yes	Yes	Assigned
Telnet	23	Yes	No	Assigned

Custom Applications

You can define up to ten custom applications.

Add custom application: Use this button to add a new row to the custom application list.

Custom Applications

You can define your own applications, and then turn them on or off as needed. To define an application, you need to know the outgoing ports used by the application.

On	App Name	Start Port	End Port	Protocol	Delete
<input checked="" type="checkbox"/>	Custom App 1			TCP	<input type="checkbox"/>

- **On:** Check this box if you want the new application to be able to access the Internet.
- **App Name:** Enter a name for the custom application.

* **Yes** indicates the protocol is standardized for the port number.

No indicates the protocol is not standardized for the port number.

Assigned indicates the port number is assigned by IANA (Internet Assigned Numbers Authority) for protocol use, but may not be standardized.

- **Start Port:** Enter the beginning of the range of port numbers used by outgoing traffic for the custom application being added.
- **End Port:** Enter the end of the range of port numbers used by the application.

NOTE: If the application uses a single port instead of a range, type the same value for both the **Start Port** and the **End Port**.

- **Protocol:** Select the protocol used by the port range from the drop-down list (TCP, UDP, or both).
- **Delete:** Check this box to delete a custom application. **NOTE:** Click on the Port Filtering tab again to remove deleted custom applications from view on the screen.

Click **Save Changes** to save any changes made to the custom applications.

Port Forwarding Tab

Port Forwarding allows incoming traffic from the Internet to be forwarded to a particular device connected to your Wi-Fi network. Normally, the built-in firewall blocks incoming traffic from the Internet. Port forwarding allows Internet users to access any server you are running on your computer, such as a Web, FTP, or Email server. For some online games, port forwarding must be used in order for the games to function correctly.

Important: Port forwarding creates a security risk and should not be turned on unless it is required.

Some mobile networks provide you with an IP address on their own network rather than an Internet IP address. In this case, Port Forwarding cannot be used, because Internet users cannot reach your IP address.

The screenshot shows the inseeego M2000 settings application. The top navigation bar includes the inseeego logo, signal strength, 5G connectivity, battery level, and a Sign Out button. The left sidebar lists settings categories: Home, Data Usage, Wi-Fi, Connected Devices (with a red notification icon), Settings (highlighted), About, and Help. The main content area is titled 'Advanced' and contains sub-menus: Preferences, Software Update, Backup and Restore, GPS, and Port Forwarding (selected). Below these are further sub-menus: Networks, Manual DNS, SIM, Firewall, MAC Filter, LAN, Port Filtering, Port Forwarding (selected), VPN, and Inseeego Connect. A toggle switch for 'Port forwarding' is currently turned off. Below the toggle is a table with columns for 'Application' and 'Application IP address'. The table lists several applications with checkboxes and empty input fields for IP addresses: DNS, FTP, HTTP/HTTPS, NNTP, POP3/POP3S, SMTP/Secure SMTP, SNMP, Telnet, and TFTP. Below the table is a section for 'Custom Applications' with a button to 'Add custom application' and a 'Save Changes' button at the bottom.

Application	Application IP address
<input type="checkbox"/> DNS	<input type="text"/>
<input type="checkbox"/> FTP	<input type="text"/>
<input type="checkbox"/> HTTP/HTTPS	<input type="text"/>
<input type="checkbox"/> NNTP	<input type="text"/>
<input type="checkbox"/> POP3/POP3S	<input type="text"/>
<input type="checkbox"/> SMTP/Secure SMTP	<input type="text"/>
<input type="checkbox"/> SNMP	<input type="text"/>
<input type="checkbox"/> Telnet	<input type="text"/>
<input type="checkbox"/> TFTP	<input type="text"/>

Port forwarding

To turn on port forwarding, move the **ON/OFF** slider to **ON**.

To turn off port forwarding, so that no inbound traffic is forwarded to a LAN client, move the slider to **OFF**.

Check the box next to each Port Forwarding application that you want to allow.

To forward all inbound WAN traffic on a specific port to a single LAN client, enter the IP address of the target device in the **Application IP Address** field.

Click **Save Changes**.

The following table provides port numbers and protocol information for each port forwarding application listed.

Application Name	Port	TCP*	STCP*	UDP*
DNS	53	Yes	No	Yes
FTP control (command)	21	Yes	Yes	Assigned
FTP data transfer	20	Yes	Yes	Assigned
HTTP	80	Yes	Yes	Assigned
HTTPS	443	Yes	Yes	Assigned
NNTP	119	Yes	No	Assigned
POP3	110	Yes	No	Assigned
POP3S	995	Yes	No	Yes
SMTP	25	Yes	No	Assigned
SecureSMTP	465	Yes	No	No
SNMP	161	Assigned	No	Yes
Telnet	23	Yes	No	Assigned
TFTP	69	Assigned	No	Yes

* **Yes** indicates the protocol is standardized for the port number.

No indicates the protocol is not standardized for the port number.

Assigned indicates the port number is assigned by IANA (Internet Assigned Numbers Authority) for protocol use, but may not be standardized.

Custom Applications

You can add up to ten custom applications. Once defined, these applications can be turned on and off the same way as pre-defined applications.

Add Custom Application: Use this button to add a new row to the custom applications list.

Custom Applications

You can define your own applications, and then turn them on or off as needed. To define an application, you need to know the incoming ports used by the application.

On	App Name	IP Address	Port Type	Port Numbers		Protocol	Delete
<input checked="" type="checkbox"/>	Custom App 1		Range	From	To	TCP	<input type="checkbox"/>

- **On:** Check this box if you want the application to be able to access the Internet (enabling port forwarding).
- **App Name:** Enter a name for the custom application.
- **IP Address:** If you want to limit service for the application to a single connected device, enter the IP address of the target device. To find the IP address of a device, go to the Connected Devices page. **NOTE:** To ensure the device you are forwarding to does not have a different IP address after a reboot, either statically assign the IP address on the client device, or set up a DHCP reservation.
- **Port Type:** Select Range or Translate from the drop-down list.
- **Port Numbers:** Use the **From** and **To** fields to specify the range of port numbers to be forwarded. **NOTE:** If the application uses a single port instead of a range, type the same value in both the **From** and **To** fields.

For translate ports, use the **Ext.** and **Int.** to specify ports. **NOTE:** Forwarding takes inbound traffic on a port to the same port on a client device. Use translate ports to send traffic to a different port on the client device. For example, instead of having inbound traffic on port 1234 forward to port 1234 of the client device, you can have it forward to port 5678.

- **Protocol:** Select the protocol used by the port range from the drop-down list (TCP, UDP, or both).
- **Delete:** Check this box to delete a custom application. **NOTE:** Click on the Port Forwarding tab again to remove deleted custom applications from view on the screen.

Click **Save Changes** to save any changes made to the custom applications.

VPN Tab

Use this page to establish a tunnel connection to an OpenVPN server and route all traffic on connected devices through the tunnel.

The screenshot shows the inseeego M2000 user interface. At the top left is the 'inseeego M2000' logo. At the top right are icons for signal strength, 5G connectivity, 100% battery, and a 'Sign Out' button. A left sidebar contains navigation options: Home, Data Usage, Wi-Fi, Connected Devices (with a red notification icon), Settings (highlighted), About, and Help. The main content area is titled 'Advanced' and includes sub-tabs for Preferences, Software Update, Backup and Restore, GPS, and Advanced (selected). Below these are further sub-tabs: Networks, Manual DNS, SIM, Firewall, MAC Filter, LAN, Port Filtering, Port Forwarding, VPN (selected), and Inseeego Connect. A note states: 'When an Open VPN tunnel is established Port Filtering and Port Forwarding settings will not be effective. There is no need for connected devices to use their own VPN client.' Underneath is a section for 'VPN Settings' with the message: 'You have not configured this M2000 for OpenVPN yet.' A blue button labeled 'Configure Open VPN Settings' is located at the bottom right.

VPN Connection

This section is visible once you have configured your M2000 for OpenVPN.

Connection status: The status of the VPN connection.

Connection time: The amount of time the VPN connection has been established.

Connect: Connects to the VPN server.

View log: Displays the VPN connection log.

VPN Settings

To configure a VPN connection, click **Configure Open VPN Settings**.

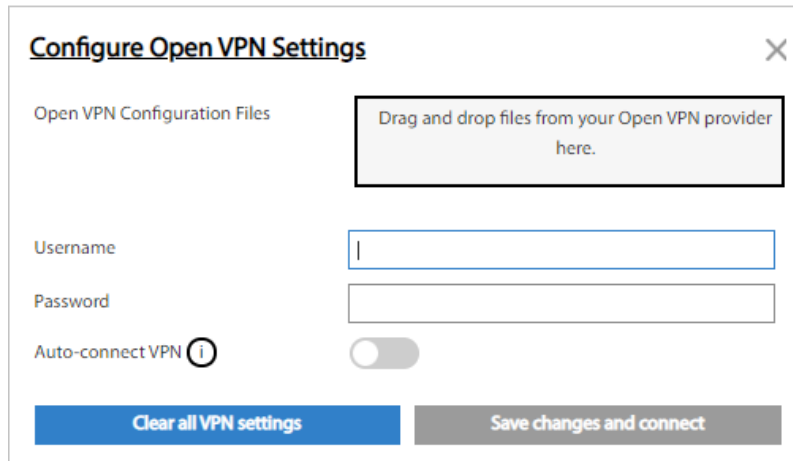

Configure Open VPN Settings X

Open VPN Configuration Files

Username

Password

Auto-connect VPN (i)

Clear all VPN settings **Save changes and connect**

Open VPN Configuration Files: Drag and drop the OpenVPN configuration files from your OpenVPN provider in the file upload area.

Username: Enter your OpenVPN connection username here.

Password: Enter your OpenVPN connection password here.

Auto-connected VPN: When the **Auto-connect VPN ON/OFF** slider is **ON**, the VPN tunnel will automatically be established whenever an Internet connection is made. When **OFF**, the VPN connection must be established manually.

Clear all VPN settings: This button deletes all VPN files, logs, and resets all VPN settings.

Click **Save changes and connect** to save your configurations and connect to the VPN server.

Inseego Connect Tab

Use this page to enable and configure settings for connection with Inseego Connect. Inseego Connect is a cloud platform product that provides 360 degree visibility and secure accessibility into your deployment from a single platform.

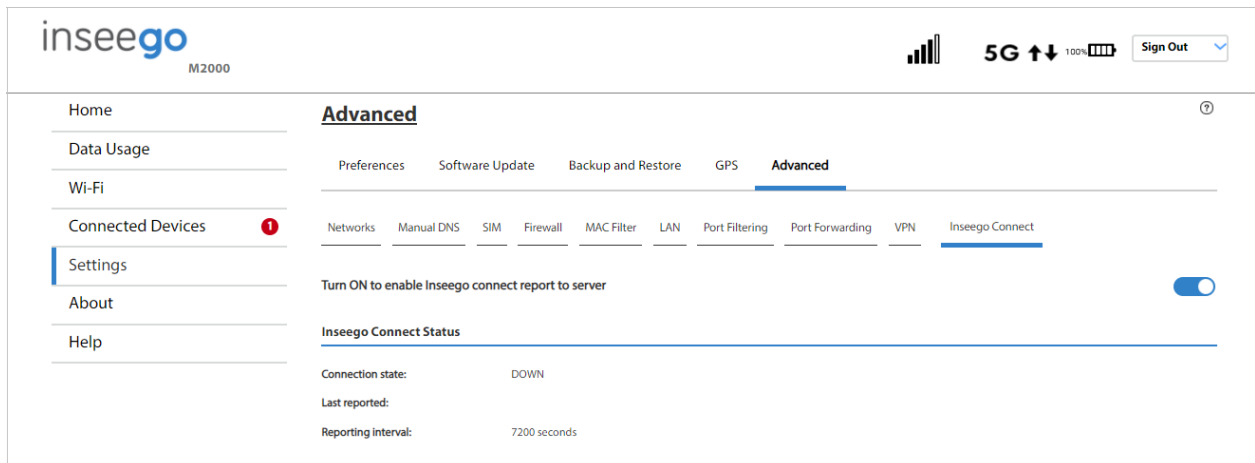

Use the **ON/OFF** slider to turn the connection to Inseego Connect **ON** or **OFF**.

Inseego Connect Status

Connection state: The status of the Inseego Connect connection.

- **UP** – M2000 is communicating with Inseego Connect servers.
- **DOWN** – M2000 is NOT communicating with Inseego Connect servers.

Last reported: The time when your M2000 last sent a packet to Inseego Connect servers.

Reporting interval: This is the interval at which your M2000 will send packets into the Inseego Connect server. **NOTE:** A shorter interval means more data usage.

5

Troubleshooting and Support

Overview

Common Problems and Solutions

Technical Support

Overview

The M2000 is a highly reliable product. Most problems are caused by one of these issues:

- System resources required by the M2000 are being used by other devices.
- Network coverage is unavailable due to coverage area, an account problem, or a network problem.

First Troubleshooting Steps

- Make sure you are using the M2000 in the correct geographic region.
- Ensure that your wireless coverage extends to your current location.
- Ensure you have an active data plan.

IMPORTANT: Before contacting support, be sure to restart both your connected device and your M2000, and ensure that your SIM card is inserted correctly.

Common Problems and Solutions

The solutions in this section can help solve many common problems encountered while using the M2000.

My M2000 powered off without pressing the Power button

This may occur under any of the following circumstances:

- Pressing the RESET button or Restore Factory Settings on the touchscreen or Admin Web UI
- M2000 automatically restarting after configuration changes
- Switching profiles
- Restoring the configuration settings
- Battery depletion

To restore power, follow these steps:

1. Manually press and hold the M2000 Power button for three seconds to turn it back on.
2. If the battery is depleted, charge the M2000 with the wall charger.

No service is available

- Reorient your device. If you are inside a building or near a structure that may be blocking the signal, change the position or location of the device. For example, try moving your device close to a window.
- You are outside your coverage area, or there may be a problem with your account. Check with your network operator.

My M2000 has no power/touchscreen doesn't display when I press the Power button

- Make sure the battery is properly seated in the device.
- Check that the battery is fully charged.

I forgot my Wi-Fi password

Tap **Wi-Fi Name/Password** to see your Wi-Fi name (SSID) and Wi-Fi password.

I forgot my M2000 Admin website password

- Your initial M2000 Admin website password is the same as your Wi-Fi password.
- If you have changed your Admin password, click **I forgot the Admin password** in the Sign In display. After you correctly answer the security question you set up, the current password is displayed.

I cannot connect a device to my M2000

On your M2000: Make sure the Network Signal Strength indicator  displays at least one bar and that the type of network is displayed on the Home screen (for example, **5G**).

On the device you want to connect: Make sure Wi-Fi is turned on. The M2000 will broadcast its own wireless network and name. Open the list of available Wi-Fi networks. Select the M2000 primary or guest network and enter the password.

NOTE: You can find the primary network name and password by tapping **Wi-Fi Name/Password** on your M2000 – swipe left to see the guest network name and password.

Once connected to the Internet, the M2000 Home screen displays the connected device.

I see the network name, but cannot connect a device to my M2000

Tap **Wi-Fi Name/Password** on the M2000 Home screen to make sure you are using the correct Wi-Fi password. Swipe left to view the guest network credentials if you are connecting to the guest network.

I want to see how many devices are connected

On the M2000 touchscreen: Look below the **Connected Devices** icon  on the Home screen for the number of connected devices. Tap the icon for details on the connected devices.

On the M2000 Admin website: The **Connected Devices** panel on the Home page lists the number of connected devices to the right of **Connected Devices**. Click > in the bottom-right corner of the panel for details on connected devices.

I want to see the firmware (software) version installed on my M2000

NOTE: Software updates are delivered to the M2000 automatically over the mobile network.

On the M2000 touchscreen: Tap **Menu** and then swipe up and tap **Software Update**.

On the M2000 Admin website: Click > in the bottom-right corner of the **Settings** panel and select the **Software Updates** tab.

I want to see the phone number for my M2000

On the M2000 touchscreen: Tap **Menu** and then swipe up and tap **About**. Your M2000 phone number is listed as **Wireless Number**.

On the M2000 Admin website: Click > in the bottom-right corner of the **About** panel and select the **Diagnostics** tab. Your M2000 phone number is listed as **Mobile number (MDN)**.

I want to see the battery level of my M2000

On the M2000 touchscreen: You can view the battery icon and percentage **100%**  on the top right of the Home screen.

On the M2000 Admin website: You can view the battery icon and percentage on the top right of the Home page.

I want to turn my M2000 off

Press and hold the Power button on the M2000 for three seconds until you see the Power Off screen. Then select **Shutdown** and tap **OK**.

I want to know if my M2000 is still on when the touchscreen is dark

- The when the M2000 is on, the LED status light on the blinks slowly as a “sign of life”.

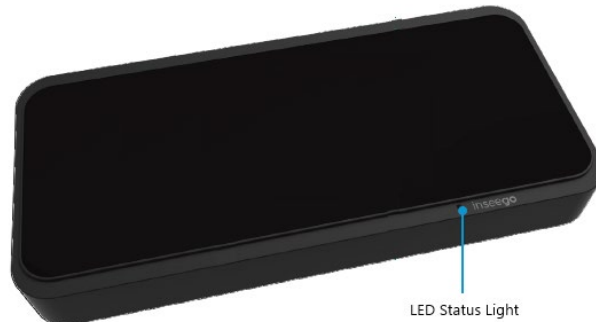

- You can press and release the Power button to wake up the touchscreen.

Technical Support

IMPORTANT: Before contacting Support, be sure to restart both your computer and your M2000, and ensure that your SIM card is inserted correctly.

Customer Service and Troubleshooting

Contact your service provider for assistance.

More Information

Documentation for your MiFi M2000 is available online. Go to www.inseego.com/support-documentation. Or, from the M2000 Admin website, select **Help > Online Support > Device Support Page & User Guide**.

6

Product Specifications and Regulatory Information

Product Specifications

Regulatory Information

Product Certifications and Supplier's Declarations of Conformity

Wireless Communications

Limited Warranty and Liability

Safety Hazards

Proper Battery Use and Disposal

Product Specifications

Device

Name:	5G MiFi M2000	
Model:	M2000A, M2000C, M2000D	
Regulatory:	M2000A	FCC, ISED
	M2000C	CE
	M2000D	MIC
Dimensions:	5.9" x 2.2" x 0.70" (150mm x 70mm x 17.9mm)	
Weight:	7.40 oz (210 g)	
Operating Temperature:	14° to 131°F (-10°C to 55°C)	
Ports:	USB-C Port – (Charging, tethering, universal charging of external devices)	
SIM:	4FF Nano SIM	
Chipset:	Qualcomm® Snapdragon™ SDX55	
Display:	2.4" (60.96mm) Touchscreen Power Indicator LED	
Languages:	English, Spanish	

Environmental

Operating Temperature:	14° to 131°F (-10°C to 55°C)
Storage Temperature:	-30° C to 70° C (-22° F to 158° F)
Battery Charging Temperature:	0° C to 40° C (32° F to 104° F)
Relative Humidity:	The device shall be fully operational up to a maximum of 93% relative humidity (non-condensing).
Drop:	The device accessories (battery and charger) shall withstand drop from 1.5m onto hard surface (stone, concrete, metal) without mechanical, electrical, or functional damage, except for slight scratches or mars. The housing will withstand drop from 1.25m onto hard surface (stone, concrete, metal) without mechanical, electrical, or functional damage, except for slight scratches or mars.
Electrostatic Discharge:	The device shall be able to withstand the following ESD: 8kV contact / 15kV air discharge.
Vibration Stability:	The device shall be able to withstand the following vibration profile: 10-2000Hz, 1.5G acceleration, 3 axes.

Power

Charging:	14.4W Qualcomm-Enabled Quick Charger USB Type A to C Cable
Time for Full Charge:	3 hours (when not in use)
Battery:	3500 mAh Li-Ion Battery (included) 8500 mAh Li-Ion (sold separately)
Battery Life:	All day

Network Connectivity*

5G Sub6/mmWave or Sub6 Only
4G LTE CAT 22
4x4 MIMO Sub6, 2x2 MIMO mmW
256 QAM Sub6, 64 QAM mmW
HSPA+/UMTS

Wi-Fi

Wi-Fi 6: 802.11 a/ac/b/g/n/ax (2.4GHz/5.0GHz)
2x2 MIMO
Supports up to 30 Wi-Fi Enabled Devices
Real Simultaneous Dual-Band Wi-Fi
Primary and Guest Wi-Fi Networks

Software

Systems Supported:	Windows® 10 Mac OS® X 10.13 or Higher Linux® Ubuntu 16.04 or Higher Chromebook™ and Microsoft® Surface
Security	AES 128 Encryption, 3rd Party Penetration Testing, Wi-Fi Security (WPA/WPA2/WPA3), Wi-Fi Protected Setup (WPS), Wi-Fi Privacy Separation, VPN Pass-Through, OpenVPN, MAC Address Filtering, NAT Firewall, Port Forwarding, Port Filtering, Security Hardened Web Interface, Password Hash, Anti-CSRF, Session Timeout, Wi-Fi On/Off Control, Incorrect Password Lockout, Admin Password to Lockout

Warranty and Services

Industry Leading Warranty
Inseego Care Support and Advanced Replacement Options Available
MiFi Provisioning Available to Apply Custom Templates and Verify Device Activation Prior to Shipment

* Data plan required. Coverage subject to network availability.

Regulatory Information

Federal Communications Commission Notice (FCC – United States)

FCC ID: PKRISGM2000A

Electronic devices, including computers and wireless modems, generate RF energy incidental to their intended function and are therefore subject to FCC rules and regulations.

This equipment has been tested to, and found to be within the acceptable limits for a Class B digital device, pursuant to part 15 of the FCC Rules. These limits are designed to provide reasonable protection against harmful interference when the equipment is operated in a residential environment.

This equipment generates radio frequency energy and is designed for use in accordance with the manufacturer's user manual. However, there is no guarantee that interference will not occur in any particular installation. If this equipment causes harmful interference to radio or television reception, which can be determined by turning the equipment off and on, you are encouraged to try to correct the interference by one or more of the following measures.

- Reorient or relocate the receiving antenna.
- Increase the separation between the equipment and the receiver.
- Connect the equipment into an outlet on a circuit different from that to which the receiver is connected.
- Consult the dealer or an experienced radio/television technician for help.

This device complies with Part 15 of the Federal Communications Commission (FCC) Rules. Operation is subject to the following two conditions.

- This device may not cause harmful interference.
- This device must accept any interference received, including interference that may cause undesired operation.

WARNING: DO NOT ATTEMPT TO SERVICE THE WIRELESS COMMUNICATION DEVICE YOURSELF. SUCH ACTION MAY VOID THE WARRANTY. THIS DEVICE IS FACTORY TUNED. NO CUSTOMER CALIBRATION OR TUNING IS REQUIRED. CONTACT INSEEGO CORP TECHNICAL SUPPORT FOR INFORMATION ABOUT SERVICING YOUR WIRELESS COMMUNICATION DEVICE.

FCC CAUTION: Any changes or modification not expressly approved by the party responsible for compliance could void the user's authority to operate this equipment.

MODIFICATIONS: The FCC requires that you be notified that any changes or modifications made to this device that are not expressly approved by Inseego Corp. may void your authority to operate the equipment.

NOTE: The Radio Frequency (RF) emitter installed in your modem must not be located or operated in conjunction with any other antenna or transmitter, unless specifically authorized by INSEEGO CORP.

Innovation, Science and Economic Development Notice (ISED – Canada)

IC: 3229A-M2000A

ISED RSS-Gen Notice

This device contains license-exempt transmitter(s)/receiver(s) that comply with Innovation, Science and Economic Development Canada's license-exempt RSS(s). Operation is subject to the following two conditions:

1. This device may not cause interference.
2. This device must accept any interference, including interference that may cause undesired operation of the device.

L'émetteur/récepteur exempt de licence contenu dans le présent appareil est conforme aux CNR d'Innovation, Sciences et Développement économique Canada applicables aux appareils radio exempts de licence. L'exploitation est autorisée aux deux conditions suivantes:

1. L'appareil ne doit pas produire de brouillage.
2. L'appareil doit accepter tout brouillage radioélectrique subi, même si le brouillage est susceptible d'en compromettre le fonctionnement.

The device for operation in the band 5150–5250 MHz is only for indoor use to reduce the potential for harmful interference to co-channel mobile satellite systems.

Les dispositifs fonctionnant dans la bande de 5 150 à 5 250 MHz sont réservés uniquement pour une utilisation à l'intérieur afin de réduire les risques de brouillage préjudiciable aux systèmes de satellites mobiles utilisant les mêmes canaux.

ISED Canada ICES-003 Compliance

CAN ICES-3 (B)/NMB-3(B)

FCC RF Exposure Guidance Statement

In order to comply with FCC RF Exposure requirements, this device must be installed to provide at least 10 mm separation from the human body at all times.

Afin de se conformer aux exigences d'exposition RF FCC / ISED, cet appareil doit être installé pour fournir au moins 10 mm de séparation du corps humain en tout temps.



Inseego Corp. declares that M2000C is in Compliance with the Radio Equipment Directive 2014/53/EU, its essential requirements and other relevant provisions of the directive.

A full copy of the EU declaration of conformity is available at the following internet address:
<https://www.inseego.com/support/>.

The Declaration of Conformity may be also consulted at Inseego Corp., 9710 Scranton Rd., Suite 200 San Diego, USA.

RF Radiation Exposure Guidance Statement

This device must be installed to provide at least 10 mm separation from the human body at all times.

Radio Frequency and Transmitted Output Power Information

Band	Max Power	Frequency
WCDMA BAND I	24 dBm	1920-1980 MHz
WCDMA BAND VIII	24 dBm	880-915MHz
LTE BAND 1	24 dBm	1920-1980 MHz
LTE BAND 3	24 dBm	1710-1785 MHz
LTE BAND 7	24 dBm	2500-2570 MHz
LTE BAND 8	24 dBm	880-915 MHz
LTE BAND 20	24 dBm	832-862 MHz
LTE BAND 28	24 dBm	703-748 MHz
LTE BAND 38	24 dBm	2570-2620 MHz
LTE BAND 40	24 dBm	2300-2400 MHz
LTE BAND 42	19.5 dBm	3400-3600 MHz
FR1 n1 (NSA)	24 dBm	1920-1980 MHz
FR1 n3 (NSA)	24 dBm	1710-1785 MHz
FR1 n7 (NSA)	24 dBm	2500-2570 MHz
FR1 n8 (NSA)	24 dBm	880-915 MHz
FR1 n28 (NSA)	24 dBm	703-748 MHz
FR1 n40 (NSA)	24 dBm	2300-2400 MHz
FR1 n41 (NSA)	24 dBm	2496-2690 MHz
FR1 n78 (NSA)	24 dBm	3300-3800 MHz
WLAN ISM	17 dBm	2.4 GHz
WLAN UNII-1	9 dBm	5.2 GHz
WLAN UNII-3	9 dBm	5.8 GHz

Japan Ministry of Internal Affairs and Communications (MIC)

Model: M2000D

W52 Indoor use only.

W52屋内利用限定

Product Certifications and Supplier's Declarations of Conformity

Product Certifications and Supplier's Declarations of Conformity documentation may be consulted at Inseego Corp., 9710 Scranton Road Suite 200, San Diego CA 92121, USA.

<https://www.inseego.com/support/>.

Wireless Communications

IMPORTANT: Due to the transmission and reception properties of wireless communications, data occasionally can be lost or delayed.

This can be due to the variation in radio signal strength that results from changes in the characteristics of the radio transmission path. Although data loss is rare, the environment where you operate the modem might adversely affect communications.

Variations in radio signal strength are referred to as fading. Fading is caused by several different factors including signal reflection, the ionosphere, and interference from other radio channels.

Inseego Corp. or its partners will not be held responsible for damages of any kind resulting from the delays or errors in data transmitted or received with the M2000 device, or failure of the M2000 device to transmit or receive such data.

Limited Warranty and Liability

Inseego Corp. warrants for the 12-month period immediately following receipt of the Product by Purchaser that the Product will be free from defects in material and workmanship under normal use. THESE WARRANTIES ARE EXPRESSLY IN LIEU OF ALL OTHER WARRANTIES, EXPRESS OR IMPLIED, INCLUDING, WITHOUT LIMITATION, ALL IMPLIED WARRANTIES OF MERCHANTABILITY AND FITNESS FOR A PARTICULAR PURPOSE.

The exclusive remedy for a claim under this warranty shall be limited to the repair or replacement, at Inseego's option, of defective or non-conforming materials, parts or components. The foregoing warranties do not extend to (I) non-conformities, defects or errors in the Products due to accident, abuse, misuse or negligent use of the Products or use in other than a normal and customary manner, environmental conditions not conforming to Inseego's specification, of failure to follow prescribed installation, operating and maintenance procedures, (II) defects, errors or nonconformities in the Product due to modifications, alterations, additions

or changes not made in accordance with Inseego's specifications or authorized by Inseego, (III) normal wear and tear, (IV) damage caused by force of nature or act of any third person, (V) shipping damage, (VI) service or repair of Product by the purchaser without prior written consent from Inseego, (VII) products designated by Inseego as beta site test samples, experimental, developmental, reproduction, sample, incomplete or out of specification Products, or (VIII) returned products if the original identification marks have been removed or altered.

Safety Hazards

Do not operate the 5G MiFi M2000 in an environment that might be susceptible to radio interference resulting in danger, specifically:

Areas where prohibited by the law

Follow any special rules and regulations and obey all signs and notices. Always turn off the host device when instructed to do so, or when you suspect that it might cause interference or danger.

Where explosive atmospheres might be present

Do not operate your device in any area where a potentially explosive atmosphere might exist. Sparks in such areas could cause an explosion or fire resulting in bodily injury or even death. Be aware and comply with all signs and instructions.

Users are advised not to operate the device while at a refueling point or service station. Users are reminded to observe restrictions on the use of radio equipment in fuel depots (fuel storage and distribution areas), chemical plants or where blasting operations are in progress.

Areas with a potentially explosive atmosphere are often but not always clearly marked. Potential locations can include gas stations, below deck on boats, chemical transfer or storage facilities, vehicles using liquefied petroleum gas (such as propane or butane), areas where the air contains chemicals or particles, such as grain, dust or metal powders, and any other area where you would normally be advised to turn off your vehicle engine.

Near medical and life support equipment

Do not operate your device in any area where medical equipment, life support equipment, or near any equipment that might be susceptible to any form of radio interference. In such areas, the host communications device must be turned off. The device can transmit signals that could interfere with this equipment.

On an aircraft, either on the ground or airborne

In addition to FAA requirements, many airline regulations state that you must suspend wireless operations before boarding an airplane. Please ensure that the modem is turned off prior to boarding aircraft in order to comply with these regulations. The modem can transmit signals that could interfere with various onboard systems and controls.

While operating a vehicle

The driver or operator of any vehicle should not operate a wireless data device while in control of a vehicle. Doing so will detract from the driver or operator's control and operation of that vehicle. In some countries, operating such communications devices while in control of a vehicle is an offense.

Electrostatic Discharge (ESD)

Electrical and electronic devices are sensitive to electrostatic discharge (ESD). Macintosh native connection software might attempt to reinitialize the device should a substantial electrostatic discharge reset the device. If the software is not operational after an ESD occurrence, then restart your computer.

Proper Battery Use and Disposal

IMPORTANT: In the event of a battery leak:

- Do not allow the liquid to come in contact with the skin or the eyes. If contact has been made, wash the affected area with large amounts of water and seek medical advice.
 - Seek medical advice immediately if a battery has been swallowed.
 - Communicate the appropriate steps to be taken if a hazard occurs. Due to the transmission and reception properties of wireless communications, data occasionally can be lost or delayed.
-

Please review the following guidelines for safe and responsible battery use:

- Do not disassemble or open, crush, bend or deform, puncture, or shred.
- Do not modify or remanufacture, attempt to insert a foreign object into the battery, immerse or expose to water or other liquids, or expose to fire, explosion, or other hazard.
- Only use the battery for the system for which it was specified.
- Only use the battery with a charging system that has been qualified with the system per IEEE 1725. Use of an unqualified battery or charger may present a risk of fire, explosion, leakage, or other hazard.
- Do not short circuit a battery or allow a metallic or conductive object to contact the battery terminals.
- Replace the battery only with another battery that has been qualified with the system per IEEE 1725. Use of an unqualified battery may present a risk of fire, explosion, leakage, or other hazard.
- Promptly dispose of used batteries in accordance with local regulations.
- Battery usage by children should be supervised.

- Avoid dropping the M2000 or battery. If the M2000 or the battery is dropped, especially on a hard surface, and the user suspects damage, take it to a service center for inspection.
- Improper battery use may result in a fire, explosion, or other hazard.



Waste Electrical and Electronic Equipment (WEEE)

This symbol means that according to local laws and regulations your product and/or its battery shall be disposed of separately from household waste. When this product reaches its end of life, take it to a collection point designated by local authorities. Proper recycling of your product will protect human health and the environment.

7

Glossary

Glossary

- **4G LTE**—Fourth Generation Long Term Evolution. LTE is a standard for wireless data communications technology and an evolution of the GSM/UMTS standards. The goal of LTE is to increase the capacity and speed of wireless data networks using new DSP (digital signal processing) techniques and modulations that were developed around the turn of the millennium. A further goal is the redesign and simplification of the network architecture to an IP-based system with significantly reduced transfer latency compared to the 3G architecture. The LTE wireless interface is incompatible with 2G and 3G networks, so that it must be operated on a separate wireless spectrum
- **5G**—Fifth Generation. The successor to 4GLTE technology, offering greater bandwidth and higher download speeds. In addition to serving cellular networks, 5G networks can be used as internet service providers, competing with other ISPs. 5G also opens up new IoT and M2M possibilities. Wireless devices must be 5G enabled to use 5G networks.
- **802.11 (a, b, g, n, ax)** — A set of WLAN Wi-Fi communication standards in the 2.4 and 5 GHz frequency bands.
- **APN** — Access Point Name. The name of a gateway between a mobile network and another computer network, often the Internet.
- **bps** — Bits per second. The rate of data flow.
- **Broadband** — High-capacity high-speed transmission channel with a wider bandwidth than conventional modem lines. Broadband channels can carry video, voice, and data simultaneously.
- **DHCP** — Dynamic Host Configuration Protocol. Software found in servers and routers that automatically assigns IP addresses and other configuration data to computers, tablets, printers, and other devices connection to the IP network.
- **DHCP Server** — A server or service with a server that assigns IP addresses.
- **DMZ** — demilitarized zone. A sub-network that contains and exposes an organization's external-facing services to an untrusted network, usually a larger network such as the Internet.
- **DNS** — Domain Name System. A system for converting host names and domain names into IP addresses on the Internet or on local networks that use the TCP/IP protocol.
- **Firmware** — A computer program embedded in an electronic device. Firmware usually contains operating code for the device.
- **FTP** — File Transfer Protocol. A standard network protocol used to transfer computer files between a client and server.
- **GB** — Gigabyte. A multiple of the unit byte for digital information storage. Usage depends on context. When referring to disk capacities it usually means 10^9 bytes. It also applies to data transmission quantities over telecommunication circuits.

- **Gbps** — Gigabits per second. The rate of data flow.
- **Hotspot** — A Wi-Fi (802.11) access point or the area covered by an access point. Used for connecting to the Internet.
- **HTTP**—Hypertext Transfer Protocol. An application-level protocol for accessing the World Wide Web over the Internet.
- **IEEE** — Institute of Electrical and Electronics Engineers. An international technical/professional society that promotes standardization in technical disciplines.
- **IMAP** — Internet Message Access Protocol. An Internet standard protocol for accessing email from a remote server from email clients. IMAP allows access from multiple client devices.
- **IMEI** — International Mobile Equipment Identity. Used in LTE networks to identify the device. It is usually printed on the device and can often be retrieved using a USSD code.
- **IP** — Internet Protocol. The mechanism by which packets are routed between computers on a network.
- **IP type** — The type of service provided over a network.
- **IP address**—Internet Protocol address. The address of a device attached to an IP network (TCP/IP network).
- **ISP**—Internet Service Provider. Also referred to as the service carrier, an ISP provides Internet connection service (See Network Operator).
- **Kbps** — Kilobits per second. The rate of data flow.
- **LAN** — Local Area Network. A type of network that lets a group of computers, all in close proximity (such as inside an office building), communicate with one another. It does not use common carrier circuits though it can have gateways or bridges to other public or private networks.
- **MAC Address**—Media Access Control. A number that uniquely identifies each network hardware device. MAC addresses are 12-digit hexadecimal numbers. This is also known as the physical or hardware address.
- **Mbps** — Megabits per second. The rate of data flow.
- **MNO** — Mobile Network Operator. The vendor that provides your wireless access. Known by different names in different regions, some examples are: wireless provider, network provider, or cellular carrier.
- **MSID** — Mobile Station IDentifier. A number for a mobile phone that identifies that phone to the network.
- **Network Operator**—The vendor that provides your wireless access. Known by different names in different regions, some examples are: wireless provider, network provider, or cellular carrier.
- **Network Technology**—The technology on which a particular network provider’s system is built; such as LTE or GSM.

- **NMEA port** — National Marine Electronics Association port. The port through which applications can access a GPS data stream.
- **NNTP** — Network News Transfer Protocol. The primary protocol used to connect to Usenet servers and transfer news articles between systems over the Internet.
- **POP3** — Post Office Protocol 3. A protocol in which email is received and held for you by your Internet server until you download it.
- **Port** — A virtual data connection used by programs to exchange data. It is the endpoint in a logical connection. The port is specified by the port number.
- **Port Forwarding** — A process that allows remote devices to connect to a specific computer within a private LAN.
- **Port Number** — A 16-bit number used by the TCP and UDP protocols to direct traffic on a TCP/IP host. Certain port numbers are standard for common applications.
- **PRL** — Preferred Roaming List. A list that your wireless phone or device uses to determine which networks to connect with when you are roaming (Network operator specific).
- **Protocol** — A standard that enables connection, communication, and data transfer between computing endpoints.
- **Proxy** — A firewall mechanism that replaces the IP address of a host on the internal (protected) network with its own IP address for all traffic passing through it.
- **Router** — A device that directs traffic from one network to another.
- **RSSI** — Received Signal Strength Indicator. An estimated measure of how well a device can hear a signal from an access point or router. RSSI value is pulled from the device's Wi-Fi card (hence "received" signal strength), so it is not the same as transmit power from an access point or router.
- **SIM** — Subscriber Identification Module. Found in LTE and GSM network technology, the SIM is a card containing identification information for the subscriber and their account. The SIM card can be moved to different devices.
- **SMTP** — Simple Mail Transfer Protocol. The standard protocol for sending emails across the Internet.
- **SNMP** — Simple Network Management Protocol. An Internet protocol used to manage and monitor network devices and their functions.
- **SSID** — Service Set Identifier. The name assigned to a Wi-Fi network.
- **TCP/IP** — Transmission Control Protocol/Internet Protocol. The set of communications protocols used for the Internet and other similar networks.

- **TFTP**—Trivial File Transfer Protocol. An Internet software utility for transferring files that is simpler to use than FTP, but does not provide user authentication and directory visibility supported by FTP.
- **Telnet** — A user command and underlying TCP/IP protocol that allows a user on one computer to log into another computer that is part of the same network.
- **TTY**—Text Telephones (TTY), also known as Telecommunications Device for the Deaf (TDD), are used by the deaf, hard-of-hearing, and individuals with speech impairments to communicate.
- **UDP**—User Datagram Protocol (UDP) is a communications protocol that offers a limited amount of service when messages are exchanged between computers in a network that uses the Internet Protocol (IP). UDP is an alternative to the Transmission Control Protocol (TCP) and, together with IP, is sometimes referred to as UDP/IP.
- **USB**—Universal Serial Bus. A connection type for computing device peripherals such as a printer, mobile modem, etc.
- **USB Port Types**—USB ports on computers and hubs have a rectangular Type A port, and peripheral devices have a cable with a Type A connector. Peripheral devices that do not have an attached cable typically have a Type C port on the device and a separate Type A to C cable. Type B connectors have been replaced by Type C. Mini-USB connectors have largely been superseded by Micro-USB, but are still used with some cameras, music players, etc. Micro-USB connectors are used with portable devices, such as phones and battery packs, although USB-C is being adopted by most manufacturers.
- **USSD** — Unstructured Supplementary Service Data (USSD), also known as “Quick code” or “Feature code”, is a communications protocol used to send data between a mobile device and network service provider.
- **VPN**—Virtual Private Network. A secure private network that runs over the public Internet. Commonly used to connect to an office network from elsewhere.
- **Wi-Fi**—Any system that uses the 802.11 standard developed and released in 1997 by the IEEE.
- **Wi-Fi 5**—The fifth generation of Wireless Fidelity, using 802.11ac on 5 GHz. This standard was developed and released in 2013.
- **Wi-Fi 6**—The sixth generation of Wireless Fidelity, using 802.11ax on licensed exempt bands between 1 and 6 GHz. This standard was developed in 2020.
- **Wi-Fi Client** — A wireless device that connects to the Internet via Wi-Fi
- **WPA/WPA2**— Wi-Fi Protected Access. A security protocol for wireless 802.11 networks from the Wi-Fi Alliance.

- **WPA3**—The next generation of Wi-Fi Protected Access. WPA3 simplifies security, provides more robust authentication, increased cryptographic strength, and offers additional capabilities for personal and enterprise networks. WPA3 retains interoperability with WPA2 devices.